

Mount'n Mover Mounting Systems

*DO MORE - with a
mount that MOVES!*

Mount'n Mover™
by BlueSky Designs

mountnmover.com

2018



Anthony uses a Dual Arm for his speech device. He loves that he can move it:

- to pull up to a table
- to exercise at the gym
- to transfer

Unsurpassed innovation, flexibility, style, and independence!

Move beyond the limits of static mounts!



Move it!

Independently move it to:

- transfer
- pull up to tables
- for driving or watching TV



Multi-task!

Position and secure multiple devices (pg 7)



Do More!

Trays optimize access for functional independence. Eat, work, read, and more! (pg 12 + 13)



Swap it!

Swiftly and easily change devices: iPad, speech device, laptop, phone, camera and more! (pg 12,13,14)

Experience Powerful, New Independence!

Move your mount with the touch of a switch with a Mount'n Mover Pow!r Hybrid System (pg 8 + 9)

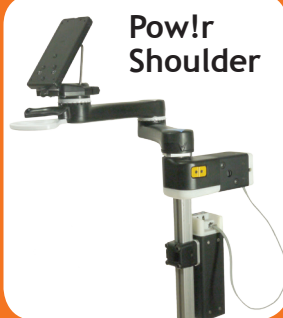

Pow!r Shoulder



Pow!r Tilt



" I love how my Mount'n Mover allows me to access my laptop in the wide variety of environments in which I work. It is sturdy and adapts easily when my needs change. Having the Mount'n Mover has increased my independence and been a lifesaver for me! "

Dawn

Get Started!

1. Choose your mount:

Mount'n Movers - Pages 4-5

- Independently move
- Custom memory locks
- Locking tilt

Easy Movers - Page 6

NEW!

- Customizable resistance to hold position
- Quick Connect Receiver or Tilt Plate
- Movable joints and tilt
- Non-locking

Simple Mounts - Page 7

3 Options: Quick Connect, Small or Large Tray

NEW!

- Change tilt (high or low resistance)
- Swivel
- Fold flat
- Store to the side

Pow!r Mounts - Pages 8-9

NEW!

- Power joint - Shoulder or Tilt
- Switch accessible
- Programmable memory positions

2. Choose what you want to attach:

Tray, speech device, camera, phone - pages 12-14

3. Choose where you want to mount it:

Wheelchair, table, floor stand - pages 15-18

Tilt'n Turner



Single Arm



Dual Arm

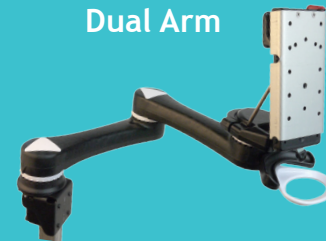

Easy Mover
Dual Arm



Easy Mover
Single Arm



Dual and Single Arms are also available with a non-locking Tilt Plate

Simple Mounts



Quick
Connect



Small
(3.5" x 7.0" x .25")



Large
(9.0" x 11.5" x .375")

Mount'n Mover
With
Pow!r Shoulder



Mount'n Mover
With Pow!r Tilt



* Not sure what you need? contact us - we are here to help.
See our website for wheelchair mounting and more!

Mount'n Mover

Tilt'n Turner / Single Arm / Dual Arm

The Next Generation has arrived!

It has a new look and added functionality!



- More precise fine tuning for eye gaze
- Twice the lock positions
- Increased forward tilt of the tilt plate (now 0° to 110°)
- New Link Cube
- Now in black!

* Silver model below is no longer available



Memory Lock Positions

Adjustable memory lock settings allow customized, consistent, and repeatable positioning of devices. Each joint offers up to 24 possible lock positions

Tilt'n Turner

- 1 rotational joint
- 24 Lock tabs/possible lock positions
- Tilt adjustable/locking tilt
- Very compact
- Position in front of armrest

MO-TQ-H (high resistance hinge)

MO-TQ-L (low resistance hinge)

Tip: Add a second device to a Dual or Single Arm Mount'n Mover — create a Double Decker!



Single Arm

Full extension 7.5 to 10.5 inches from the Shoulder to the Wrist Joint

- 2 rotational joints
- 24 lock tabs per joint
- 576 possible lock positions
- Simple to move
- More compact than Dual Arm
- Locking tilt

M1-TQ-H

(high resistance hinge)

M1-TQ-L

(low resistance hinge)



Shown:
Optional Link Cube
Configuration

Tip:

We recommend the High Resistance Hinge for heavier devices (5 lbs. or greater)



Quick Release Plate allows for quick and easy attachment and removal for a wide variety of devices

Increased forward tilt- ideal for eye gaze (0° to 110°)



The Quick Connect Receiver (QCR) (page 11) can be attached to the Quick Release Plate (QCP)

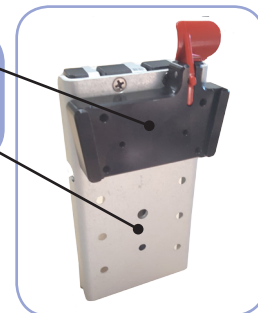

Paddle unlocks the wrist joint so you can easily rotate a tray or device

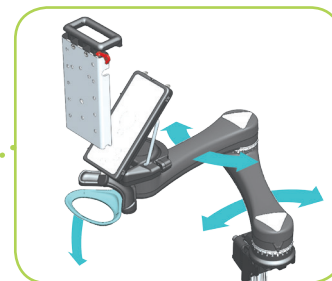

Unlock and Move Easily
Hoop unlocks both the elbow and shoulder joints simultaneously to make moving between operating positions easy

Dual Arm

Full extension 15 to 18 inches from the Shoulder to the Wrist Joint

- 3 rotational joints
- 24 Lock tabs per joint
- 13,824 possible lock positions
- Most versatile
- Requires little reach

Link Cube options:

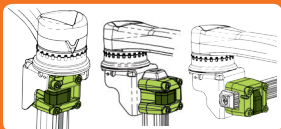

M2-TQ-H
(high resistance hinge)
M2-TQ-L
(low resistance hinge)



Tilt angle adjustment:
easy lateral movement
unlocks the tilt

Easy Mover

Dual Arm / Single Arm

NEW!

Quick Connect Release

Increased forward tilt - 0-140° - ideal for eye gaze (up to 0-180° depending on device)

Hinge - available with either high or low resistance

Black finish

New Quick Connect Receiver

Sleeker without paddle or hoop

Customizable resistance at joints

- Movable mount for speech devices, trays, cameras, and more!
- New Quick Connect Receiver is compatible with other mounts and devices
- Hinge on Easy Mover is available with either low or high resistance
- Joints can be adjusted from low to high resistance, low resistance requires less effort to move, high resistance requires more strength to move
- Joints can be fully tightened to lock
- Tilt does not lock
- Sleek design
- Lower price
- Weight limit 10 pounds

Single Arm



EM1-QC-H
EM1-QC-L

With New Quick Connect!

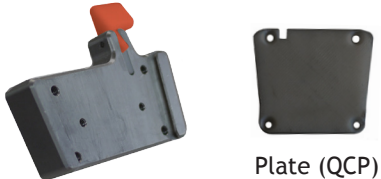

Receiver (QCR) Plate (QCP) (sold separately)

Link Cube with three attachment options

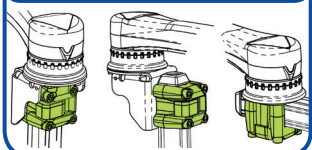

Dual Arm
EM2-QC-H (high resistance hinge)
EM2-QC-L (low resistance hinge)

Also available with non-locking Tilt Plate



EM1-TP-H EM1-TP-L Compatible with Quick Release Plate

Simple Mounts



Quick Connect / Small Tray / Large Tray

What makes them so great?

- Simple yet sturdy - holds up to 15 pounds
- Ideal for phones, remotes, iPads, tablets, speech devices, cameras, eating, writing, and reading!
- Create a double-decker with a Dual or Single Arm system
- Securely attaches to wheelchairs or table with Mount'n Mover hardware (sold separately)



Quick Connect



New Quick Connect Receiver is compatible with other mounts and devices (see web for order number)

Simple Mount Small



3.5" x 7" x .25"
Tilts / Swivels
(see web for order number)

Simple Mount Large



9" x 11.5" x .375"
Tilts / Swivels
(see web for order number)



Trays include Lip Supports:

- Adhesive - backed
- Place them anywhere
- Small tray includes 1
- Large tray includes 2
- Additional sets of 6 (sold separately)



Combine with a Dual or Single Arm to make a double decker! Or use two mounts! (see photo above)

The Simple Mounts include a post attached to a variable angle hinge. The hinge is available in either a high or low resistance. Choose your post length: 8", 12", 18", 24", or 36"

Clear tray swivels 360°, lays horizontal, tilts 0 - 90° and folds down flat to the side!

Attaches to wheelchairs using Mount'n Mover Wheelchair Hardware (sold separately)

For tables, use a Table Clamp



Pow!r Mount Hybrid Systems

Introducing the first power Mount'n Mover for independent device positioning

Mount'n Mover with Pow!r Shoulder

Hybrid configuration: Mount'n Mover and Pow!r Joint



Pow!r Shoulder Benefits:

Move to the side:

- For transfers
- To pull up to a table or sink
- To see to drive
- To increase independence
- Use from wheelchair, table, or bed
- For safety and well-being



Features:

- Single or Dual switch directional control
- Customizable target positions
- Rechargeable battery included
- Attach: Trays, speech devices, camera, laptop, or suction tube
- Built-in keypad for attendant
- Supports and moves up to 15 pounds

PM-HBD-S-H (high resistance hinge)

PM-HBD-S-L (low resistance hinge)

Mount'n Mover with Pow!r Tilt

Hybrid configuration: Mount'n Mover and Pow!r Joint



PM-HBD-T

Pow!r Tilt Benefits:

Move it to:

- Use your device
- See where you are driving
- Avoid glare
- Visual access in a reclined position

Single Switch A:
Toggle directions

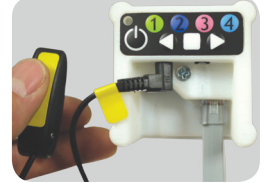

- Activate switch (or use arrow keys)
- Joint moves while held
- Let up, it stops
- Next activation, other direction

Single Switch B:
Two Target positions

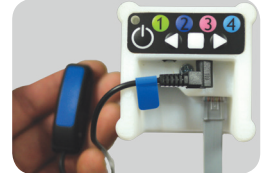

- Activate switch and release
- Moves to a target position
- Activate and release
- Joint goes to second target position
- Click switch while moving it stops

Two Switches:
Direction-specific

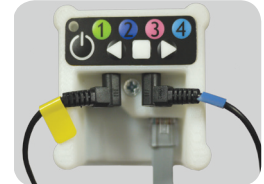

- Activate and hold Switch A
- Stops when released
- Activate Switch B to go other way

Communicate all the time, everywhere!



Tana's communication device used to stay in her backpack at school and only come out when she was in a classroom where it could be placed securely on a table. Now, it is always accessible for conversation and can be safely, easily and independently repositioned as needed - even in a standing position.

Swap devices quickly Attach any device with ease

Device plates have been developed to attach communication devices to the Mount'n Mover's Mounts. Common devices are listed in the chart below. More options, including custom plates, are available.



Find the attachment plate for your device

MAKE	MODEL	PLATE	
	For devices not shown - contact us	For use with Quick Release Plate (QRP)	For use with Quick Connect Receiver (QCR)
Tobii Dynavox	Maestro, T10, T15, V, Vmax, M3, DV4, MT4	DP-DV1	DP-DV1 plus DP-QCP
	EyeMax, Maestro w/eye gaze	DP-DV2	DP-DV2 plus DP-QCP
	EyeMobile	DP-MULTI1	DP-MULTI1 plus DP-QCP
	P10, C8, C12, CEye, S32,	DP-T1	DP-T1 plus DP-QCP
	I12, I15	DP-T2	DP-T2 plus DP-QCP
	I110	DP-T4	DP-T4 plus DP-QCP
	Indi	DP-QCR	QCR COMPATIBLE
Prentke Romich Co.	Accent 700, 800, 1000	DP-PRC5	QRM *
	Accent 1400, ECO2, ECOpoint, ECO-14, Vanguard, Pathfinder 2	DP-PRC1	DP-PRC1 plus DP-QCP or QRM *
and	Accent 1200, Vantage Lite, Springboard Lite	DP-QCR *	QRM *
Salttillo	NOVA chat	DP-QCR *	QRM *
Others	(Jabbla)-Mobi/Tellus, (Abilia)-Rolltalk, AMDI, VESA (50,75,100mm), Smartbox	DP-MULTI1	DP-MULTI1 plus DP-QCP
Talk to Me Technologies	Eyespeak 12+18, Zuvo 12+18, Wego 10+13	DP-QCR	QCR COMPATIBLE
iPad/Tablets	Fits standard iPads / Tablets (11 x 8 inch maximum)	TR-iTAB	TR-iTAB plus DP-QCP
Large Tablets	Custom sizes	Contact Us	
Rehadapt	DP-QCR and DP-QCP are Rehadapt compatible	* Requires PRC'S QRM plate	

Quick Connect

Receiver

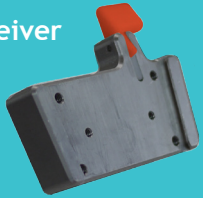

Plate



- Easy attachment and release
- Compatible with many speech devices
- QC Plate can be added to trays

DP-QCR
DP-QCP

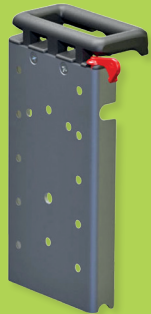

Quick Release Plate (QRP)

One Quick Release Plate comes with each Mount'n Mover (Dual Arm, Single Arm, and Tilt'n Turner). Order extra plates to make switching your devices quick and easy.

QRP

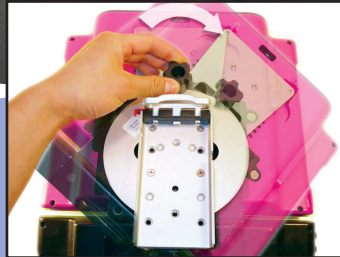

Universal Rotator (UR)

An additional degree of freedom! Infinite angle locking is great for eye-gaze systems and iPads.

DP-UR

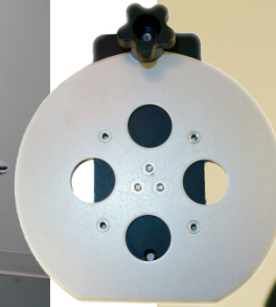

The Universal Rotator lets you lock your device at any rotation!



Trays for every use

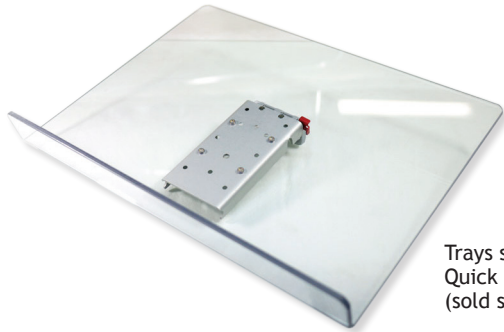

Trays shown with Quick Release Plate (sold separately)

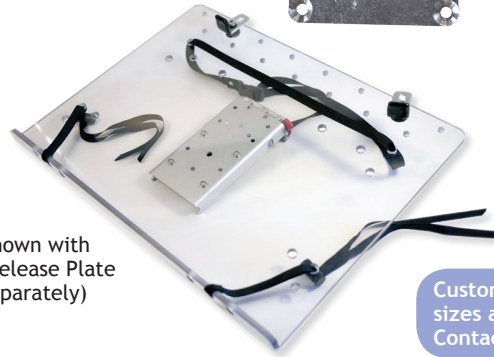

Custom tray sizes are available. Contact us!



Use a Quick Connect Plate to attach to the Quick Connect Receiver (see page 6 +11)



Add a Swing Away Tray to hold a mouse, phone, or other small devices

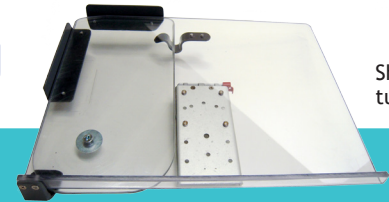

Shown tucked in

Place the tray flat and it becomes a tray for eating, writing, working and play!



Shown with original silver Mount'n Mover

12"x16" Tray with Lip

- Multi-purpose tray
- Great for books, tablets and art projects
- Angle it flat and turn it around for writing or eating

TR-12x16-Q with Quick Release Plate

TR-12x16 no Quick Release Plate

12"x16" Laptop Tray

- A mobile workstation
- Accommodates most laptops
- Secures your laptop with adjustable straps and backstops
- Easily remove your laptop

TR-LT-Q with Quick Release Plate

TR-LT no Quick Release Plate

Swing Away Tray Add-On 11.75"x6"

- Add a Swing Away Tray to a Laptop Tray or a Tray with Lip
- Tray swings out easily
- Tucks away when not in use
- Attach to either side
- Retrofits available

* See website for information

Hinged tray open



* Arm not included



With Universal Rotator

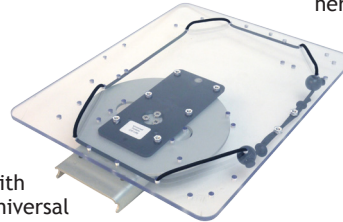

One mount - many uses!
Rosie uses her mount to take photographs, read, write, draw, and access her tablet.



Copyright © 2014 by Rosaleen Moriarty-Simmonds, Photography by James Moriarty-Simmonds

Hinged tray closed

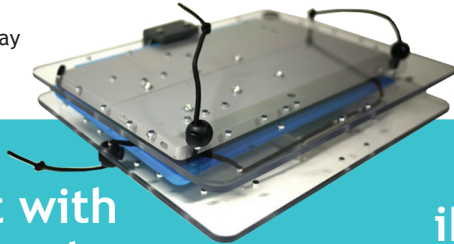

Without Universal Rotator

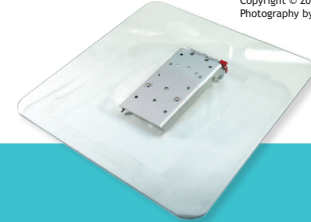
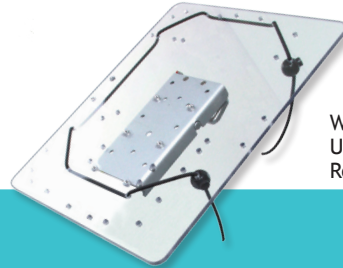

Tablet with Keyboard

- Hinged 12" x 9.5" trays
- Fits most tablets with keyboards
- Contact us for Surface Pro 4 and larger iPad Pro for larger size tray
- Folds flat for storage and transportation
- May accommodate standard keyboards, contact us

TR-iTab-Keyboard

iPad-Tablet Tray 12"x9.5"

- Get great positioning and access for the iPad and most tablets (see website for list)
- Easily switch from landscape to portrait with the Universal Rotator option
- Comes with elastic cord

TR-iTAB without Universal Rotator
 TR-iTAB-UR with Universal Rotator
 -Q add a Quick Release Plate

12"x12" Tray

- Add Velcro or Lip Supports to secure a phone or tablet
- Create an easel with a clip on the edge
- Attach a plate to it for eating, or use to hold remotes

TR-12x12-Q
 with Quick Release Plate

TR-12x12
 no Quick Release Plate

Additional options

Portrait



Landscape



Phone

- Attachment plate for mobile phone
- Includes an Otterbox Defender swivel case
- Can be rotated from portrait to landscape
- Shown with Quick Release Plate (not included)
- ✳ Must supply phone make and model at the time of order

DP-PHONE-OB

Camera Plate

- Attaches to Quick Release Plate (p.7) or add a Quick Connect Plate to attach to an Easy Mover
- Attaches directly to most cameras - with 1/4" and 3/8" screws (supplied)
- Attaches to tripod heads (not included)



After becoming frustrated trying to use a tripod and monopod, Suz was relieved to find out about the Mount'n Mover. She likes the flexibility it offers and that it allows the eye piece of the camera to be close to her eye. Attached to her power chair and tripod head, the camera goes with her everywhere and is always available to capture the perfect shot.

DP-CAM3

Universal Access Station Kit



NEW!

- Ideal for schools, clinics, evaluation centers or work.
- Includes: Easy Mover, Dual Arm, Post, Table Clamp, and iTab Tray

UAS-KIT

Table & bed solutions

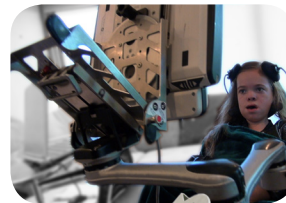

Sophia uses eye gaze to access her communication device



Stand + 90°



Two products in one!

DOWNWARD TILT for mounted devices

- Attach between a device plate or tray and Quick Release Plate
- Ideal for eye gaze access from bed
- Locks at 0°, 55° and 90°
- Use tilt lever to lock 0-180°

TABLE STAND for devices or trays

- Use with any device plate or tray
- Locks at 0° and 55° on tables

DP-STAND90

Table Clamp



Attach your mount to a table!

- Quickly adjust tilt, height and positioning
- Conduct evaluations easily
- Clamps to tables and trays (1/2" to 3")
- Attach above or below table
- Move a mount from a table to a wheelchair easily

TC

Mount'n Tilter

- Made for surface mounting
- Lightweight, portable
- Available with low resistance hinge (high resistance upon request)
- Angle can be locked in place with the tilt lever

MNTQ with Quick Release Plate
MNT without Quick Release Plate

Connect your mount to your wheelchair

* For more information see [Interactive Product Chooser](#) at [mountnmover.com](#)

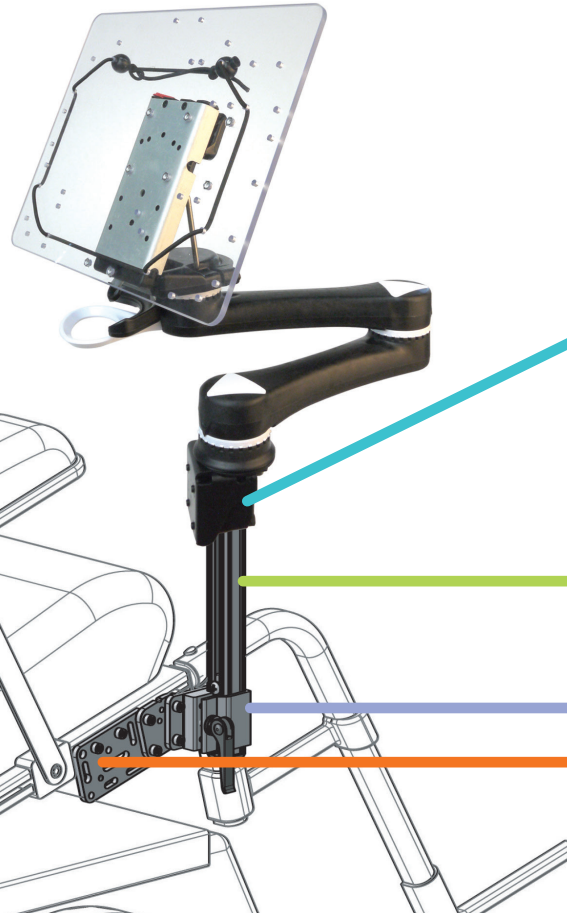

Questions?

Give us a call and we can help select the best mounting option for your wheelchair. From round tubing to slide tracks, level or angled, we have the hardware to connect your Mount'n Mover to your wheelchair.

For Dual Arms, Single Arms, Tilt'nTurner, and Easy Movers, the Link Cube offers three attachment options:

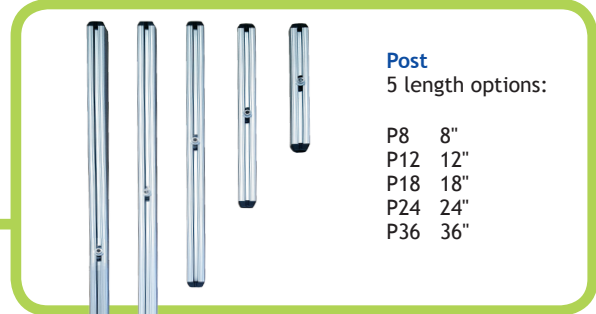
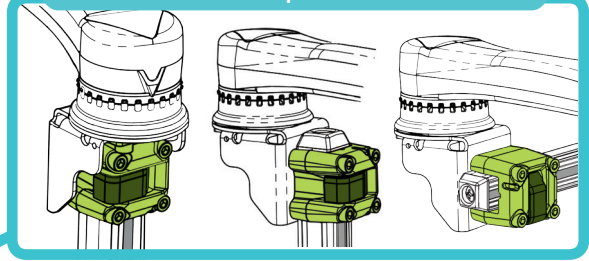

Post
5 length options:

P8 8"
P12 12"
P18 18"
P24 24"
P36 36"

Call us at 1-888-724-7002
(toll free) or 1-612-724-7002.

For help choosing hardware go to:

mountnmover.com/support/wheelchair-mounting-overview

Select your wheelchair brand and model from drop down menu to view recommendations and mounting instructions



Solid Wheelchair Bracket

- Most rigid way to attach
- Simple and compact
- Has two mounting orientations

WB2

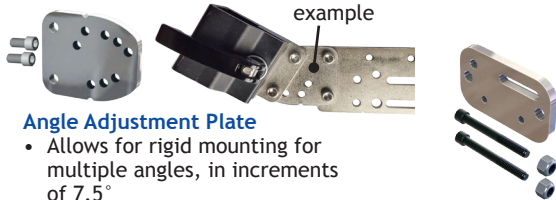

Angle Adjustment Plate

- Allows for rigid mounting for multiple angles, in increments of 7.5°
- Compatible with WB2 and all bracket mounting hardware.

Pair this with WB2 to more solidly adjust your post angle to vertical

WC-AAP

Adapter Plate

- Plate size: 3" x 1.75" x .25"

WC-AP

Adapter Plate 2

- Plate size: 4.75" x 2.25" x .25"
- Longer extension than WC-AP4

WC-AP2

Adapter Plate 4

- Plate size: 3.75" x 2.25" x .25"
- More compact than WC-AP2
- Allows for 5/16" or 8mm bolts

WC-AP4

Adapter Plate 5

- Plate size: 5.5" x 2.0" x .25"
- longest/narrowest
- Allows for 5/16" or 8mm bolts

WC-AP5

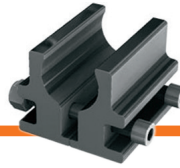

Round Clamp

- Clamps to round tubing when bolting is not an option
- Select from 1" or 7/8" size

WC-R1 1"

WC-R7/8 7/8"



Round Bridge Clamp

- Must be used in a pair with an AP2 or AP4
- Choose 1", 7/8" or mixed pairs
- Eliminates tube-slip if clamped at right-angles

WC-R1B-set 1"

WC-R7/8B-set 7/8"



Collar Clamps

- Additional round tubing option (see website for sizes)

WC-Collar



T-Nut

- Compatible with TDX and Quantum style slide tracks

WC-TN

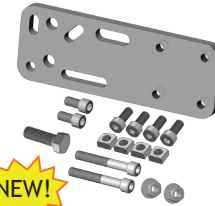
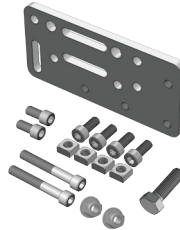

NEW!



L-Angled Extension Plate

- Can be used singly to offset mounting at 90°, or used in pairs to extend mounting from 2.25" to 4.5"
- Fully compatible with all wheelchair mounting hardware

WC-LAE

Access anything, anywhere!

Move your Mount'n Mover from your wheelchair to the Floor Stand in seconds!

Easy access from bed!

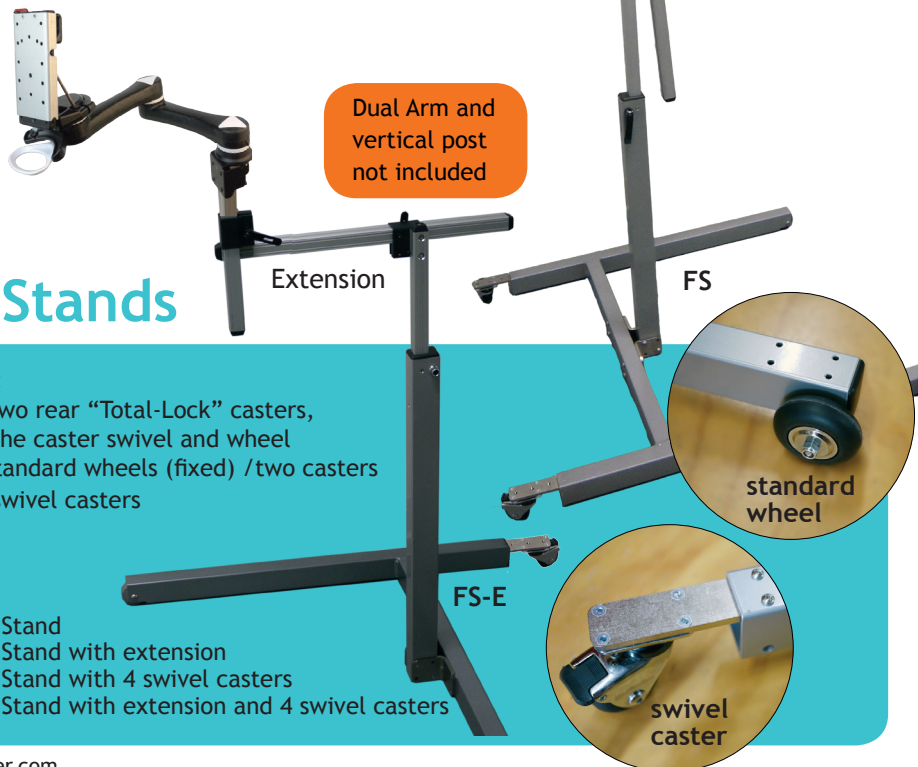

Dual Arm and vertical post not included

Floor Stands

Wheel options:

- All models: two rear "Total-Lock" casters, able to lock the caster swivel and wheel
- FS has two standard wheels (fixed) /two casters
- FS-4C has 4 swivel casters

- FS Floor Stand
- FS-E Floor Stand with extension
- FS-4C Floor Stand with 4 swivel casters
- FS-4C-E Floor Stand with extension and 4 swivel casters



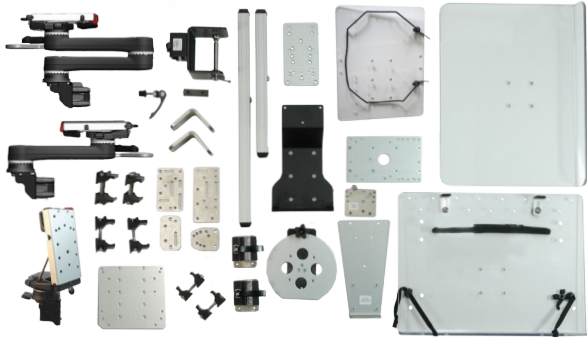

Evaluation Kits: Full, Deluxe, and Custom

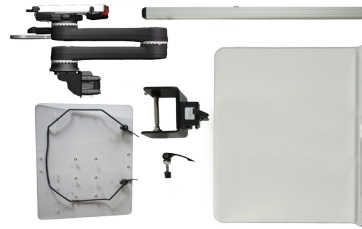

Table Evaluation Kit



Wheelchair Attachment Set

SAVE!
Kits and Sets are
Priced at a discount!

Additional kits are
available.
Contact us!

Eval Kits

Eval Kits:

Provide universal access - flexible positioning of different devices for many people to try

Conduct evaluations - evaluate a person's abilities to use different speech devices or software and input devices

Evaluate mounting options - determine which Mount'n Mover is the best option for someone and what hardware they need

Conduct trials - of iPads, speech devices, laptops and the Mount'n Mover

Attach to a wheelchair - determine what hardware is needed to attach to a wheelchair

Customize your Kit! Add other items at the time of purchase and the same discount applies

EVAL-F (Full)
EVAL-D (Deluxe)

Custom Kits Available!



We believe in hands-on trials to help a person determine what works best!

Comes with durable carrying case

See website for content details for the Full or Deluxe Eval Kit

Table Eval Kit

Kit comes with Table Clamp, iPad/Tablet Tray, Tray with Lip, one 18" Post, and Dual Arm Mount'n Mover EVAL-T

Wheelchair Attachment Set

This 16 piece set includes an 18" Post, the Solid Wheelchair Bracket, multiple plates, and assorted mounting hardware. Will attach to most standard wheelchairs that have slide track or 7/8" or 1" tubing WC-SET

If you can't afford an Eval Kit, try our *Meet the Mount'n Mover* program

Mount'n Mover™

by BlueSky Designs

2637 27th Ave. S., Suite 209
Minneapolis, MN 55406-1564

mountnmover.com

1-888-724-7002 (toll free) or 1-612-724-7002

info@blueskydesigns.us

Visit mountnmover.com for:

- How-to videos
- Wheelchair mounting support
- Resources for therapists
- Loan and rental program



Ester, an attorney who has cerebral palsy knows it's no big secret that she had been opposed to using communication devices much of her life. That is, until now. She hadn't found a communication device that matched her comprehensive vocabulary and, with her slow typing speed, the process took way too long. When she was introduced to eye gaze she had a change of heart. She embraced the technology but was discouraged when she thought she was limited to using it only at her desk at home with a table mount.

Esther said, "The mounting technology I saw had not advanced at all since the 80's. Due to my spasticity and lack of fine motor skills, I could never use these types of mounts myself. I had to rely on others to move it, and take it on and off, being 'confined to a wheelchair' had a whole new meaning."

Then her OT told her about the Mount'n Mover and she was immediately intrigued. During a trial of the mount she fell deeper in love with it. For the first time, she could move her device to transfer, access items on the table, and independently put her device on and off herself. Something she never fathomed being able to do. Finally she could take her communication device everywhere she went. ***"It's amazing how much impact a device can have on one's independence and empowerment!" states Esther.***

The Mount'n Mover is MIRACULOUS! Sarah loves it and her teachers at school say she is getting so much more work done now that she is comfortable and in a proper position.

Diane, Parent