

Mount'n Mover

by BlueSky Designs

Eval Sheet







www.mountnmover.com
 Phone: 612.724.7002 // 888.724.7002
 Fax: 888.311.4435 // Intl Fax: 612.724.7004



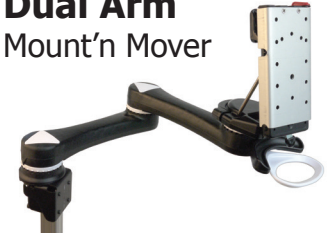

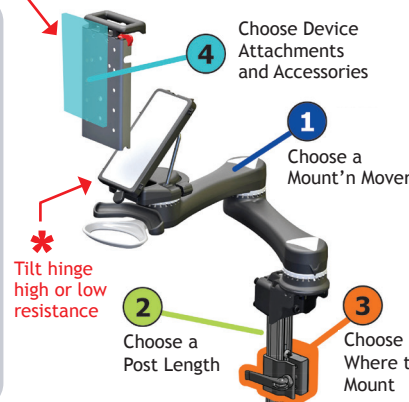
Follow these steps to fully specify a Mount'n Mover system.

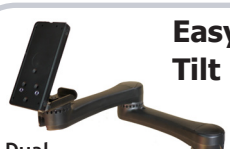
Client Name: _____
 Chair Type: _____
 Second Chair: _____
 Device(s) to Attach: _____
 Contact Name: _____
 Email / Phone: _____

Step 1 : Choose a Mount'n Mover

Note: Dual, Single Arm and Tilt'n Turner all come with a Quick Release Plate (QRP)

<p>Dual Arm Mount'n Mover</p>  <p>M2-TQ-H * <input type="checkbox"/> (High Resistance Hinge) M2-TQ-L * <input type="checkbox"/> (Low Resistance Hinge)</p>	<p>Single Arm Mount'n Mover</p>  <p>M1-TQ-H * <input type="checkbox"/> (High Resistance Hinge) M1-TQ-L * <input type="checkbox"/> (Low Resistance Hinge)</p>	<p>Tilt'n Turner</p>  <p>M0-TQ-H * <input type="checkbox"/> (High Resistance Hinge) M0-TQ-L * <input type="checkbox"/> (Low Resistance Hinge)</p>	
<p>Easy Mover with Quick Connect Receiver</p> <p>Dual</p>  <p>EM2-QC-H * <input type="checkbox"/> EM2-QC-L * <input type="checkbox"/></p>	<p>Easy Mover with Quick Connect Receiver</p> <p>Single</p>  <p>EM1-QC-H * <input type="checkbox"/> EM1-QC-L * <input type="checkbox"/></p>	<p>Easy Mover with Locking Tilt Plate</p> <p>Dual</p>  <p>EM2-TP-H* <input type="checkbox"/> EM2-TP-L* <input type="checkbox"/></p> <p>Single</p>  <p>EM1-TP-H* <input type="checkbox"/> EM1-TP-L* <input type="checkbox"/></p> <p>(QRP not included with Easy Movers)</p>	

<p>Simple Mount Large</p>  <p>Post Included. Choose Post length below</p> <p>Two Lip Supports Included</p> <p>SM-LG-H * <input type="checkbox"/> SM-LG-L * <input type="checkbox"/></p>	<p>Simple Mount Small</p>  <p>Post Included. Choose Post length below</p> <p>One Lip Support Included</p> <p>SM-S-H * <input type="checkbox"/> SM-S-L * <input type="checkbox"/></p>	<p>Simple Mount with Quick Connect Receiver</p>  <p>SM-QC-H * <input type="checkbox"/> SM-QC-L * <input type="checkbox"/></p>	<p>Additional Lip Supports for Trays</p>  <p>Set of six</p> <p>TRA-LS-1/2 <input type="checkbox"/> (1/2" tall x 2" long) TRA-LS-1 <input type="checkbox"/> (1" tall x 2" long)</p>
--	---	--	---

*** Tilt Hinge Resistance:**
 We recommend the High Resistance Hinge for heavier devices (5 lbs. [2.3 kg] or greater).
 The High Resistance Hinge deters device angle adjustment when the tilt lever is unlocked. Both **H** and **L** hinges can be securely locked using the tilt lever lock.

Step 2 : Choose a Post Length

Minimum post length is determined by the distance from the mounting point to the bottom of a person's tray or device when it is in his/her preferred operating position.
 Measure **Distance A** in the diagram and select the next longest post.

Post



8" Post	P8	<input type="checkbox"/>
12" Post	P12	<input type="checkbox"/>
18" Post	P18	<input type="checkbox"/>
24" Post	P24	<input type="checkbox"/>
<input type="text"/>	Custom Post Length inches*	

* Custom post lengths available.

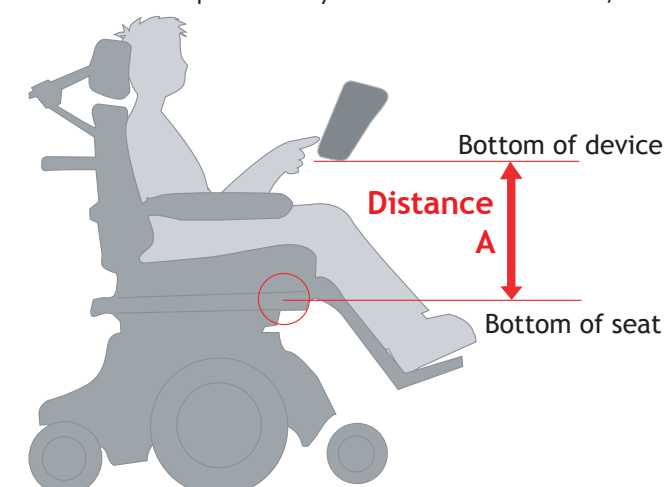

Step 3 : Choose Where to Mount

Mount to any combination of Wheelchair, Table or Floor Stand

3 : Table Solutions

Mount'n Tilter

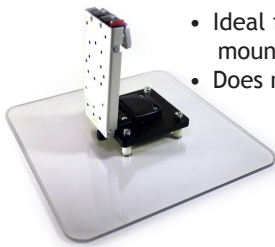

- Ideal for surface mounting
- Does not include QRP

MNT



Table Clamp



- Attach your mount to a table!
- Designed for use with Post & Mount

TC



Stand +90°

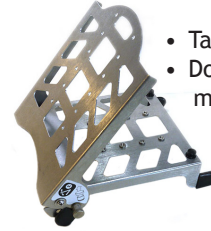

- Table stand for devices
- Downward tilt for mounted devices

DP-STAND90



3 : Floor Stands

Basic Floor Stand



Use your Mount'n Mover on a Floor Stand, move from wheelchair or table to Floor Stand in seconds. Easy access from bed!

Floor Stand Options

FS (Basic Floor Stand)



Options:

- 4C (4 "total lock" casters)



- E (Horizontal Extension)

Adds up to a 16" horizontal extension



Basic FS has 2 in-line wheels and 2 "Total-Lock" casters



in-line wheel



total-lock caster

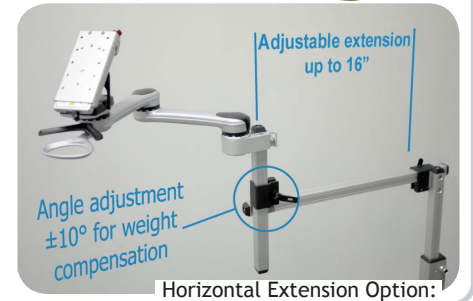

Adjustable extension up to 16"

Angle adjustment ±10° for weight compensation

Horizontal Extension Option:

3 : Attach to "other brand" Systems

Rehadapt with Tilt Plate



Customer supplies the TS-XL head

DPA-Rehadapt TS-XL



Wheelchair DAESSY adapter



Compatible with DAESSY wheelchair hardware.

WB-DAESSY



Tilt Plate Adapter

Compatible with DAESSY and Rehadapt. Other sizes available.

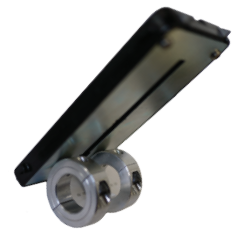

TR-TPA 1" or 7/8"



3 : Wheelchair Mounting

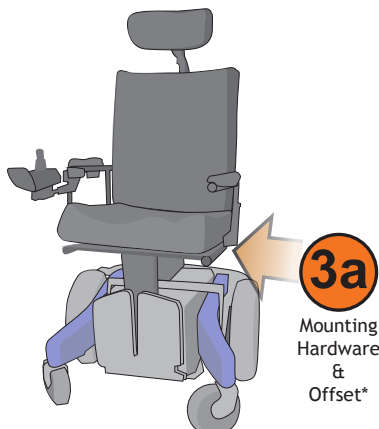

3a

Mounting Hardware & Offset*

+



3b

Wheelchair Bracket

Overview

Wheelchair Mounting is divided into two stages:

3a Select Mounting Hardware

- Direct Wheelchair Attachment
- Offset Components (Offset components are optional)

3b Select Wheelchair Bracket(s)

The Bracket is attached to the Mounting Hardware selected from 3a. The Mount'n Mover Post is then inserted into the Wheelchair Bracket square clamp.

Wheelchair Mounting - 3a Select Mounting Hardware

Multi-Purpose Plates

All Adapter Plate(s):

- Can be used with bridge clamps.
- Accommodate a range of spacing for 1/4" or 6mm bolts.

Adapter Plates 2, 4, 5 can be used for:

- Permobil UniTrack
- Permobil Corpus
- Quantum/Jazzy Tie-Downs

Adapter Plate



Most compact plate
For Hole Spacing 1"-2"

WC-AP

Adapter Plate 2



• Longer plate for offset

WC-AP2

Adapter Plate 4

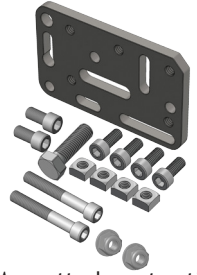

• More attachment options
• Also for 5/16" or 8mm bolts

WC-AP4

Adapter Plate 5

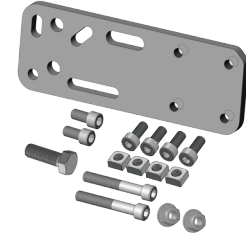

• Longest Adapter Plate
• Compatible with Permobil and T-nut
• 4 threaded holes

WC-AP5

T-Nut



Compatible with Invacare and Quantum slide track.

WC-TN

Bridge Clamp

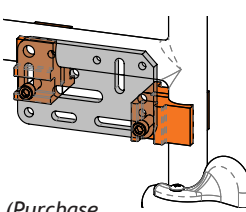

(Purchase Adapter Plate separately)

Bridge clamps must be used in pairs, spanned with an adapter plate.

Set of 2

1" Bridge Set **WC-R1B-SET**

7/8" Bridge Set **WC-R7/8B-SET**

Mixed Set (1 ea.) **WC-R-Mixed-SET**

1" Bridge (1)

7/8" Bridge (1)

Collar Clamp



Additional round tubing options (see website for sizes)

WC-Collar

Round Clamp

For mounting vertically to round tubing



1" Clamp **WC-R1**

7/8" Clamp **WC-R7/8**

Coved Spacer



• Through hole in frame
• Provides stability for plate attachment

wc-coved-1-set

wc-coved-7/8-set

Offset Options

Why Offset?

- Get around obstacles like trays, brakes, footrests and armrests.
- Position the Wheelchair Brackets and post for best position.
- Compensate for mounting angle so the post is vertical.

Adapter Plate(s) can also be used to offset mounting forward or upward.

L-Angle Extension



Can be used in pairs to extend mounting up to 7"

WC-LAE

Quantity

Adapter Plate(s)



AP2 is a longer offset.
AP4 has more options.

WC-AP2

WC-AP4

Angle Adjust Plate



Compatible with any mounting component. Adjust post to vertical (every 7.5°).

WC-AAP

Adapter Plate



4 threaded holes for Link Cube

Our longest plate. Link Cube attachment. Even more options!

WC-AP5

Wheelchair Mounting - 3b Select Wheelchair Bracket(s)

Solid Wheelchair Bracket

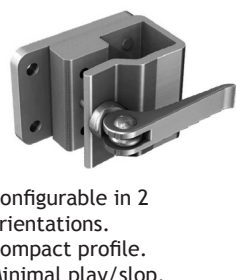

Configurable in 2 orientations.
Compact profile.
Minimal play/slop.
More secure.

WB2

Tip: Adjust the angle of the post with the WC-AAP plate

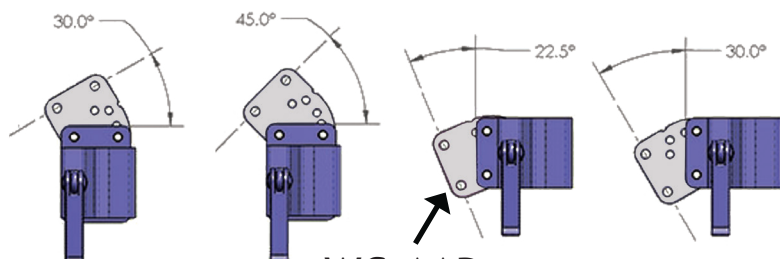

WC-AAP

Use the WB2 with the WC-AAP for mounting at an angle (7.5 degree increments)

Step 4 : Choose Device Attachments & Accessories

Access anything, anywhere! Select access for one or multiple devices and trays

4 : BlueSky Designs Accessories

Quick Release Plate



One included with each Mount'n Mover.

QRP

Quick Connect Receiver and Plate

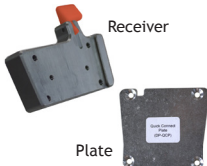

Compatible with many speech devices and mounts

DP-QCR

DP-QCP

Universal Rotator



Add a degree of freedom between tilt and device. Great for eyegaze and tablets.

DP-UR

Camera Plate



Turns a Quick Release Plate into a camera stand! Compatible with other tripod heads

DP-CAM3

Stand +90°



Extend your downward tilt range to 180°. Also use as a table stand for devices

DP-STAND90

4 : Tray Options - Reading, Laptops, iPads, etc

Note: If attaching more than one device, you will need additional QRP's or DP-QCP's

12"x 12" Tray

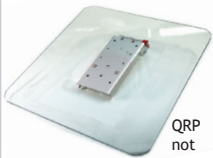

QRP not included

Multi-purpose tray. Adapt it for your needs.

TR-12x12

Add QRP

Add DP-QCP

iPad-Tablet Tray



UR not included

Great for iPad and Tablet. Easily switch from landscape to portrait with Universal Rotator (shown).

TR-iTab

TR-iTab-UR
(With Universal Rotator)

Add QRP

Add DP-QCP

12"x 16" Tray with Lip

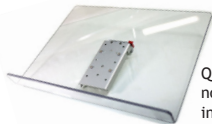

QRP not included

Multi-purpose tray with lip. Great for books, tablets, etc. Angle it flat and turn it around for writing or eating.

TR-12x16

Add QRP

Add DP-QCP

Laptop Tray

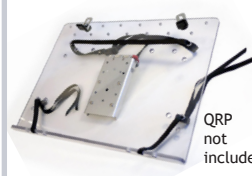

QRP not included

Tray, holes and straps fit most laptops securely. Easily remove your laptop.

TR-LT

Add QRP

Add DP-QCP

Tablet Tray (with hinge tray)



TR-iTab-Keyboard

9.5" x 12" (x2)

Add QRP

Add DP-QCP

Phone Plate

Landscape or portrait

Attachment plate for mobile phone. Includes an Otterbox Defender swivel case. Shown with Quick Release Plate (not included).



DP-PHONE-OB



Add a Swing Away Tray on a 12 x 16" or Laptop Tray to hold a mouse, phone or other small device. See website for information.

4 : Communication Device Attachments

Attach any Device with Ease

Device plates attach communication devices to the Mount'n Mover's Quick Release Plate (QRP) or Quick Connect Receiver (QCR).

One QRP comes with each Mount'n Mover.

Find the attachment plate for your device

MAKE	MODEL	PLATE
Tobii Dynavox	Maestro, T10, T15, V, Vmax, M3, DV4, MT4	DP-DV1
	EyeMax, Maestro w/eye gaze	DP-DV2
	EyeMobile	DP-MULT11
	T 7, C15 w/eye gaze	Contact Us
	P10, C8, C12, CEye, S32,	DP-T1
	I12, I15	DP-T2
	i-110, Indi	DP-QCR
Prentke Romich Co.	Accent 700, 800, 1000	DP-PRC5
	Accent 1400, ECO2, ECOpoint, ECO-14, Vanguard, Pathfinder 2	DP-PRC1
	Accent 1200, Vantage Lite, Springboard Lite, ChatWrap	DP-QCR *
Salttillo	NOVA chat (requires wheelchair mounting plate sold by Salttillo)	DP-QCR
Others	(Jabbla)-Mobi/Tellus, (Abilia)-Rolltalk, AMDI, VESA (50,75,100mm), Smartbox	DP-MULT11
iPad/Tablets	Fits most iPads / Tablets	TR-iTAB

Plates for AbleNet, Lightwriter and more are available. See website for specifics

* DP-QCR plate requires a QRM mounting bracket from Prentke Romich Co.

Device make and model