

Mount'n Mover Mounting Systems

*Gain a New Level of
Independence - with a
mount that MOVES!*

Mount'n Mover™
by BlueSky Designs

mountnmover.com

2023



Michael uses a Dual Arm to hold his tablet and easily operates his Dual Arm Mount'n Mover using one hand.

Unsurpassed innovation, flexibility, style, and independence!

Move beyond the limits of static mounts!



Move it!

Independently move it to:

- transfer
- pull up to tables
- for driving or watching TV



Multi-task!

Position, secure and access multiple devices (pg 7)



Do More!

Trays optimize access for functional independence. Eat, work, read, and more! (pg 12 + 13)



Swap it!

Swiftly and easily change devices: iPad, speech device, laptop, phone, camera and more! (pg 12,13,14)

Experience Powerful, New Independence!

Move your mount with the touch of a switch with a Mount'n Mover Pow!r Hybrid System (pg 8 + 9)



"Brylee LOVES her new mount! It's amazingly user friendly. The precise positioning capabilities are fantastic and the fact that her ideal position can be 'locked in', and easily returned to, is super helpful. Her speech device has given her a voice and the Mount'n Mover has made it easy for her to use it everywhere she goes! "

Michelle, Brylee's Mom

Get Started!

1. Choose your mount:

Mount'n Movers - Pages 4-5

- Independently move
- Custom memory locks
- Locking tilt

Easy Movers - Page 6

- Customizable resistance to hold position
- Quick Connect Receiver or Tilt Plate
- Movable joints and tilt
- Non-locking

Simple Mounts - Page 7

3 Options: Quick Connect, Small or Large Tray

- Change tilt (high or low resistance)
- Swivel, fold flat, store to the side
- Multi purpose support (arm, mouse, remote)

Pow!r Mounts - Pages 8-9

- Pow'r Joint, Pow'r Shoulder or Pow'r Tilt
- Switch accessible
- Programmable memory positions

2. Choose what you want to attach:

Tray, speech device, camera, phone - pages 12-14

3. Choose where you want to mount it:

Wheelchair, table, floor stand - pages 15-18

- * Need help? Check out our website for a Step-by-Step Guide and our Mount Mentor Eval Sheet. Or contact us - we are here to help!

Tilt'n Turner



Single Arm



Dual Arm

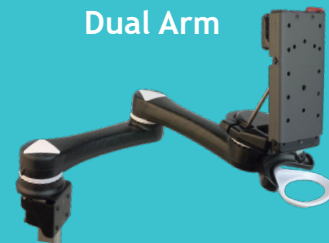

Easy Mover Dual Arm



Easy Mover Single Arm



Dual and Single Arms are also available with a locking or non-locking Tilt Plate

Simple Mounts

all simple mounts tilt, swivel and fold down to the side.

Quick Connect



Small

(3.5" x 7.0" x .25")



Large

(9.0" x 11.5" x .375")



Mount'n Mover With Pow!r Shoulder



Mount'n Mover Pow!r Joint

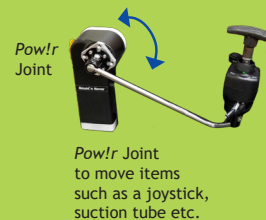

Mount'n Mover With Pow!r Tilt



Mount'n Mover

Tilt'n Turner / Single Arm / Dual Arm

Memory Lock Positioning and Locking Tilt!



- Precise fine tuning for eye gaze
- 24 positions per joint
- Adjustable Tilt from 0° (flat) to 110°
- Link Cube with 3 configurations
- Release and move easily!

Full extension: 15 - 18 inches!



Memory Lock Positions

Adjustable memory lock settings allow customized, consistent, and repeatable positioning of devices. Each joint offers up to 24 possible lock positions

Tilt'n Turner

- 1 rotational joint
- 24 Lock tabs/possible lock positions
- Tilt adjustable/locking tilt
- Very compact
- Position in front of armrest

MO-TQ-H (high resistance hinge)

MO-TQ-L (low resistance hinge)

Tip: Add a second device to a Dual or Single Arm Mount'n Mover — create a Double Decker!



Single Arm

- 2 rotational joints
- 24 lock tabs per joint
- 576 possible lock positions
- Simple to move
- More compact than Dual Arm
- Locking tilt

M1-TQ-H

(high resistance hinge)

M1-TQ-L

(low resistance hinge)

Full extension 7.5 to 10.5 inches from the Shoulder to the Wrist Joint



Shown: Optional Link Cube Configuration

Tip:

We recommend the High Resistance Hinge for heavier devices (5 lbs. or greater)

Link Cube configurations:

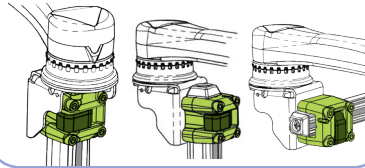

The Quick Connect Receiver (QCR) (page 11) can be attached to the Quick Release Plate (QCR)

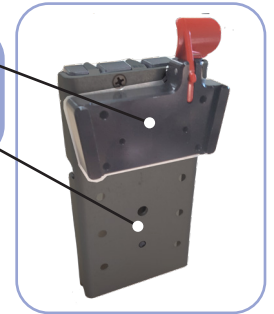

Quick Release Plate allows for quick and easy attachment and removal for a wide variety of devices

Increased forward tilt- ideal for eye gaze (0° to 110°)



Paddle unlocks the wrist joint so you can easily rotate a tray or device



Unlock and Move Easily
Hoop unlocks both the elbow and shoulder joints simultaneously to make moving between operating positions easy



Tilt angle adjustment: easy lateral movement unlocks the tilt

Dual Arm

- 3 rotational joints
- 24 Lock tabs per joint
- 13,824 possible lock positions
- Most versatile
- Requires little reach

Full extension 15 to 18 inches from the Shoulder to the Wrist Joint

Link Cube



M2-TQ-H
(high resistance hinge)
M2-TQ-L
(low resistance hinge)

Easy Mover Dual Arm / Single Arm / Tilt'n Turner

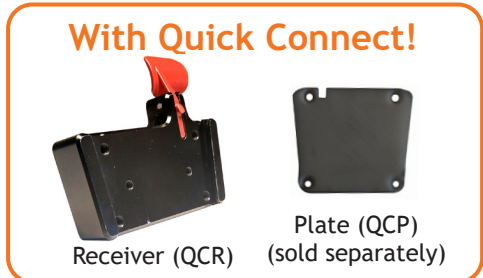
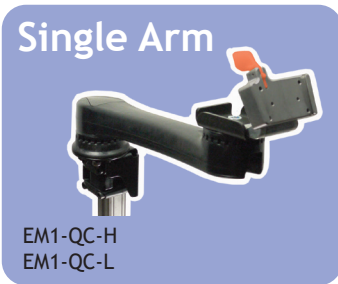
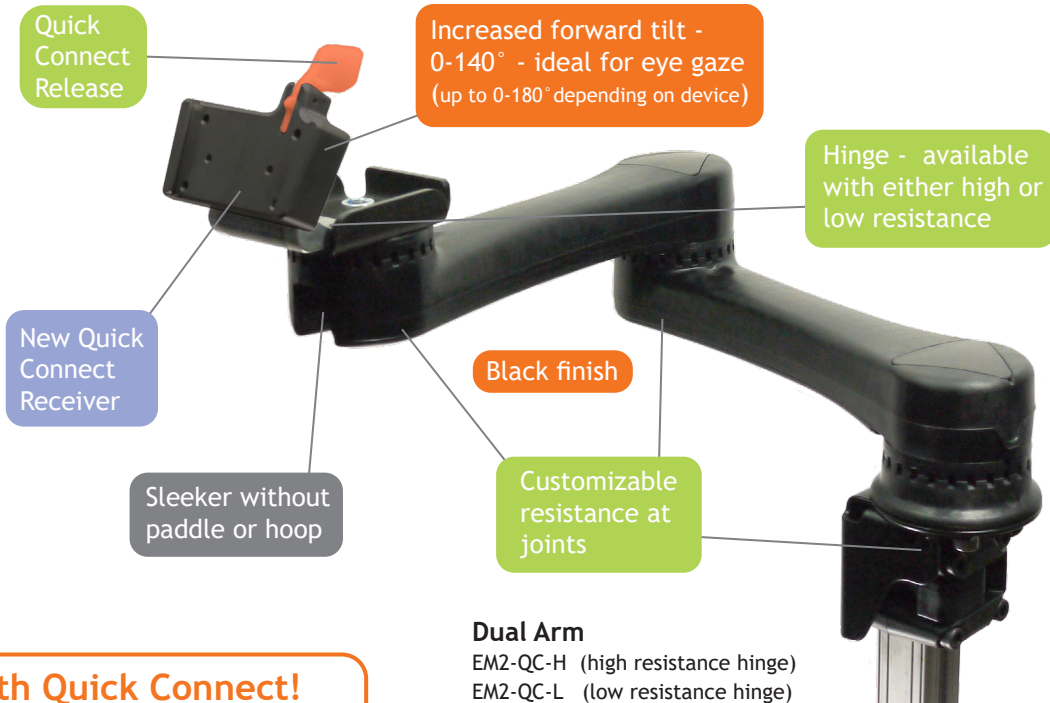

- Quick Connect Receiver is compatible with other mounts and devices
- Hinge on Easy Mover is available with either low or high resistance
- Joints can be adjusted from low to high resistance, low resistance requires less effort to move, high resistance requires more strength to move
- Tilt does not lock
- Weight limit 10 pounds

Simple Mounts

Quick Connect / Small Tray / Large Tray



What makes them so great?

- Simple yet sturdy - holds up to 15 pounds
- Ideal for phones, remotes, iPads, tablets, speech devices, mouse, switches, eating, writing, and reading!
- Create a double-decker with a Dual or Single Arm system
- Securely attaches to wheelchairs or table
- with Mount'n Mover hardware (sold separately)



Quick Connect



New Quick Connect Receiver is compatible with other mounts and devices
(see web for order number)

Simple Mount Small



3.5" x 7" x .25"

Tilts / Swivels
(see web for order number)

Simple Mount Large



9" x 11.5" x .375"

Tilts / Swivels
(see web for order number)

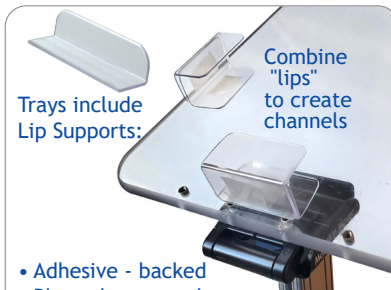

Trays include Lip Supports:

Combine "lips" to create channels

- Adhesive - backed
 - Place them anywhere
 - Small tray includes 1
 - Large tray includes 2
- Additional sets of 6 (sold separately)**



Combine with a Dual or Single Arm to make a double decker!
Or use two mounts!
(see photo above)

The Simple Mounts include a post attached to a variable angle hinge. The hinge is available in either a high or low resistance. Choose your post length: 8", 12", 18", 24", or 36"

Clear tray swivels 360°, lays horizontal, tilts 0 - 90° and folds down flat to the side!

Attaches to wheelchairs using Mount'n Mover Wheelchair Hardware (sold separately)

For tables, use a Table Clamp



Pow!r Mount Hybrid Systems

Introducing the first power Mount'n Mover for independent device positioning

Mount'n Mover with Pow!r Shoulder

Hybrid configuration: Mount'n Mover and Pow!r Joint



Pow!r Shoulder Benefits:

Move to the side:

- For transfers
- To pull up to a table or sink
- To see to drive
- To increase independence
- Use from wheelchair, table, or bed
- For safety and well-being



Features:

- Flexible positioning of a Mount'n Mover
- Single or Dual switch directional control
- Customizable target positions
- Rechargeable battery included
- Attach: Trays, speech devices, camera, laptop, or suction tube
- Built-in keypad for attendant
- Supports and moves up to 15 pounds



PM-HBD-S-H (high resistance hinge)
PM-HBD-S-L (low resistance hinge)

Mount'n Mover with Pow!r Tilt

Hybrid configuration: Mount'n Mover and Pow!r Joint





Pow!r Tilt Benefits:

Move it to:

- Use your device
- See where you are driving
- Avoid glare
- Visual access in a reclined position



Pow!r Joint!

Use a *Pow!r* Joint to add rotary motion where you need it!

Shane's uses a Pow!r Joint to move his Joystick. Read his story on our website

PM-HBD-T

Single Switch A: Toggle directions



- Activate switch (or use arrow keys)
- Joint moves while held
- Let up, it stops
- Next activation, other direction

Single Switch B: Two Target positions

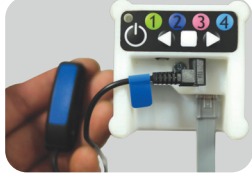

- Activate switch and release
- Moves to a target position
- Activate and release
- Joint goes to second target position
- Click switch white moving it stops

Two Switches: Direction-specific

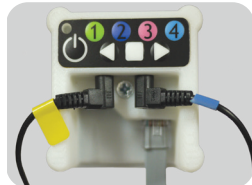

- Activate and hold Switch
- Moves one direction
- Stops when released
- Activate Switch B to go other way

Communicate all the time. everywhere!



Swap devices quickly Attach any device with ease

Device plates have been developed to attach communication devices to the Mount'n Mover's Mounts. Common devices are listed in the chart below. More options, including custom plates, are available.

Find the attachment plate for your device			
MAKE	MODEL	PLATE	
	For devices not shown - contact us	For use with Quick Release Plate (QRP)	For use with Quick Connect Receiver (QCR)
Tobii Dynavox	TD Pilot	DP-QCR **	QCR COMPATIBLE
	SC Tablet Pro (12.9 iPad)	DP-QCP plus DP-QCR	DP-QCP
	SC Tablet (iPad) Include offset hardware (x2) 3/8" spacers and (x2) M4-16 screws (DAH-SC-Tablet)	DP-QCP plus DP-QCR	DP-QCP
	EyeMobile Plus (EM12 with EyeMobile Plus)	DP-QCR **	QCR COMPATIBLE
	EyeMobile Mini Include offset hardware (x3) 3/16" spacers and (x3) M4-16 screws (DAH-EyeMobile Mini)	DP-QCR **	QRAP **
	I-110 Include offset hardware (x2) 3/8" spacers and (x2) M4-16 screws (DAH-SC-Tablet)	DP-T4	DP-T4 and DP-QCP
	Indi	DP-QCR **	QCR COMPATIBLE
	I-12, I-15	DP-T2	DP-T2 plus DP-QCP
I-13, I-16 **Add DP-EXT for IR Remote Access **	DP-T5	QCR COMPATIBLE	
Prentke Romich Co. and Salttillo	Accent 800, 1000 (Can also use DP-PRC5 plate)	DP-QCR *	QRM *
	Accent 1400	DP-QCR *	QRM *
	Accent 1200	DP-QCR *	QRM *
	NOVA chat 8, 10, 12, PRIO-mini, Chat Fusion 8,10, Via Pro, TouchChat Express Offset the mounting bracket with (x3) 6-32 x 1/2" screws and (x3) 3/16" nylon spacers (DAH-Salttillo)	DP-QCR *	QRM *
Lincare	Expression compatible with DP-QCR if they have Lincare mounting bracket	DP-QCR	QCR COMPATIBLE
Inclusive TLC	Skyle 2x2 spacer, (x4) 8-32x1-3/4" flat head screws, (x4) m4x8mm flat head screws (DAH-Skyle)	DP-MULTI1	DP-MULTI1 plus DP-QCP
Control Bionics	GridPad Trilogy	DP-QCR-E	QCR COMPATIBLE
Forbes	Winslate 12, 11, ProSlate 8, 10, 13	DP-QCR	QCR COMPATIBLE
Talk to Me Technologies	Eyespeak 12,16 Zuvo 10, 12,16 Wego 10+13	DP-QCR	QCR COMPATIBLE
	Eyespeak 18, Zuvo 18	DP-QCR-E	
EYEGAZE Inc	Eyegaze Edge	DP-EE	DP-EE plus DP-QCP
Eyeteq	EyeOn Elite, EyeOn Go	DP-QCR	QCR COMPATIBLE
Smartbox	Grid Pad 12, 15,	DP-QCR-E	QCR COMPATIBLE
	Grid Pad 10S, Talk Pad 8, 10, 13, Touch Pad,	DP-QCR	QCR COMPATIBLE
APH for Blind	Lightbox Include hardware (x4) 8-32 x 5/8" screws	DP-MULTI1	DP-MULTI1 plus DP-QCP
Jabbla	Vibe 12, Tellus 6, Tellus(i)6,	DP-QCR	QCR COMPATIBLE
RM Speech	NUVO, INSPIRE, INSPIRE XL VESA 75 and 100 hole spacing x4(11/4-20 x 1/2" screws)	DP-MULTI1	DP-MULTI1 plus DP-QCP
Others	VESA (50,75,100mm)	DP-MULTI1	DP-MULTI1 plus DP-QCP
iPad/Tablets	Fits standard iPads / Tablets (11 x 8 inch maximum)	TR-iTAB	TR-iTAB plus DP-QCP
Large Tablets	iPad Pro 12.9, Surface, Surface Pro (13.5 x 9.5 maximum)	TR-LG Tablet Tray plus DP-QCP	TR-LG Tablet Tray plus DP-QCP
Small Laptops	Lingraphica All Talk, Small Laptops (13 x 9 inch maximum)	TR-Small Laptop Tray	TR-Small Tablet Tray plus DP-QCP
Rehadapt	DP-QCR and DP-QCP are Rehadapt compatible **Requires Tobii Quick Release Adapter Plate *Requires PRC'S QRM plate		

More trays and device plates available. Call us! See website: www.mountnmover.com

Quick Connect

Receiver

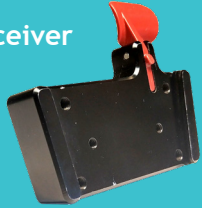

Plate



- Easy attachment and release
- Compatible with many speech devices
- QC Plate can be added to trays

DP-QCR
DP-QCP

Adapt to other brands:

CJT Adapter Plate

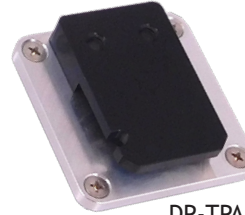

DP-TPA-CJT



DAESSY and Rehadapt round tubing adapter plate (Daessy 1", Rehadapt 7/8")

DAESSY: DP-TPA-1
Rehadapt: DP-TPA-7/8



Quick Release Plate (QRP)

The Quick Release Plate serves as the easy attach-and-release component between the Mounting system and your device(s) of choice.

Note: One Quick Release Plate comes with each Mount'n Mover (locking model). Order extra plates to make switching your devices quick and easy.
QRP

Tilt Plate Adapter with Quick Connect Plate (For: Rehadapt/ConnectIT)

An easy way to make a Mount'n Mover Quick Release Plate attach to a Rehadapt/Connect-it, Table or Floor Stand....in one step!

1. Insert the Tilt Plate Adapter with a Quick Connect Plate into the UDS

You have now made your Rehadapt Floor or Table Stand compatible with the Mount'n Mover Quick Release Plate!



DP-TPA-QCP

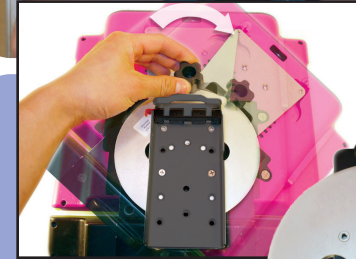

Universal Rotator (UR)

The Universal Rotator lets you lock your device at any rotation!

An additional degree of freedom! Infinite angle locking is great for eye-gaze systems and iPads.

DP-UR

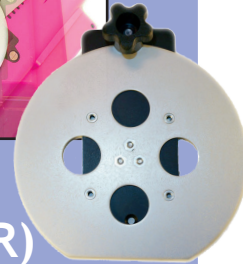

Trays for every use

Custom tray sizes and modifications are available. Contact us!



Use a Quick Connect Plate to attach to the Quick Connect Receiver (see page 6 +11)



Add a Swing Away Tray to hold a mouse, phone, or other small devices

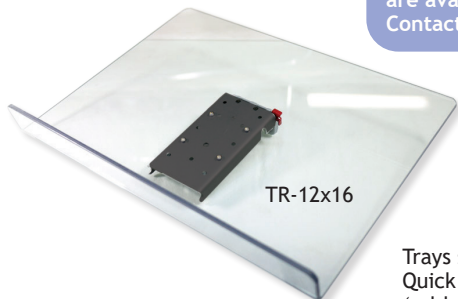

TR-12x16

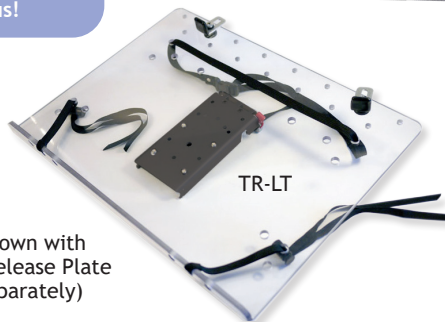

TR-LT

Trays shown with Quick Release Plate (sold separately)

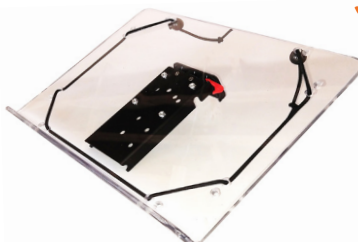

TR-LG-Tablet/
Communication Device

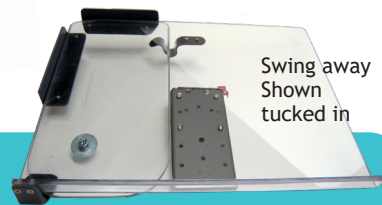

Swing away
Shown
tucked in

12" x 16" Tray with Lip

- Multi-purpose tray
- Great for books, tablets and art projects
- Angle it flat and turn it around for writing or eating

TR-12x16-Q
with Quick Release Plate

TR-12x16
no Quick Release Plate

12" x 16" Laptop Tray

- A mobile workstation
- Accommodates most laptops
- Secures your laptop with adjustable straps and backstops
- Easily remove your laptop

TR-LT-Q
with Quick Release Plate

TR-LT
no Quick Release Plate

14" x 9.75" Large Tablet / Communication Device

- Accommodates larger sized tablets
- Secures your tablet with adjustable cords and velcro
- Easily remove your tablet

TR-LG-Tablet/Communication Device-Q
with Quick Release Plate

TR-LG-Tablet/Communication Device
no Quick Release Plate

Swing Away Tray Add-On 11.75" x 6"

- Add a Swing Away Tray to any of our Trays.
- Tray swings out easily
- Tucks away when not in use
- Attach to either side
- Retrofits available

* See website for information

Hinged tray open



* Arm not included



With Universal Rotator

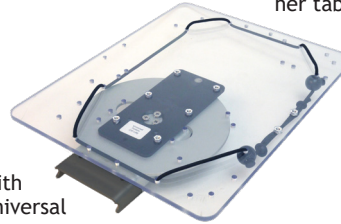

One mount - many uses!
Rosie uses her mount to take photographs, read, write, draw, and access her tablet.

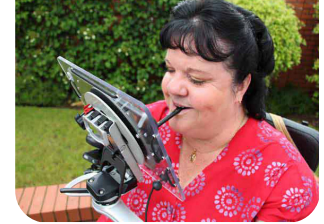

Copyright © 2014 by Rosaleen Moriarty-Simmonds, Photography by James Moriarty-Simmonds

Hinged tray closed

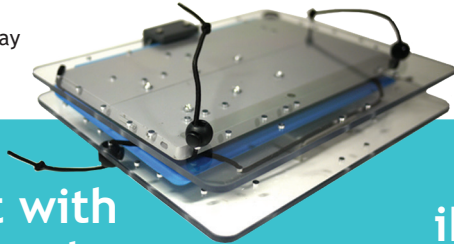

Without Universal Rotator

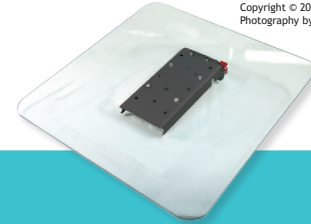
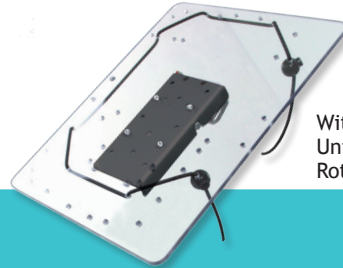

Tablet with Keyboard

- Hinged 12" x 9.5" trays
- Fits most tablets with keyboards
- Contact us for Surface Pro 4 and larger iPad Pro for larger size tray
- Folds flat for storage and transportation
- May accommodate standard keyboards, contact us

TR-iTab-Keyboard

iPad-Tablet Tray 12"x9.5"

- Get great positioning and access for the iPad and most tablets (see website for list)
- Easily switch from landscape to portrait with the Universal Rotator option
- Comes with elastic cord

TR-iTAB without Universal Rotator

TR-iTAB-UR with Universal Rotator

add a Quick Release Plate if needed

12"x12" Tray

- Add Velcro or Lip Supports to secure a phone or tablet
- Create an easel with a clip on the edge
- Attach a plate to it for eating, or use to hold remotes

TR-12x12-Q
with Quick Release Plate

TR-12x12
no Quick Release Plate

Additional options

Portrait

Landscape



Phone

- Attachment plate for mobile phone
- Includes an Otterbox Defender swivel case
- Can be rotated from portrait to landscape
- Shown with Quick Release Plate (not included)

* Must supply phone make and model at the time of order

DP-PHONE-OB



RAM PHONE MOUNTS
Attaches to device or tray



X-GRIP



QUICK-GRIP

Camera Plate

- Attaches to Quick Release Plate (p.7) or add a Quick Connect Plate to attach to an Easy Mover
- Attaches directly to most cameras with 1/4" and 3/8" screws (supplied)
- Attaches to tripod heads (not included)



DP-CAM3



Universal Access Station Kit

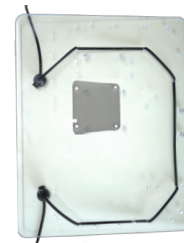

NEW!

- Ideal for schools, clinics, evaluation centers or work.
- Includes: Easy Mover, Dual Arm, Post, Table Clamp, and iTab Tray

UAS-KIT

Table & bed solutions

(Also see
Floor Stands
pg.18)



Mount'n Tilter

- Made for surface mounting
- Lightweight, portable
- Available with low resistance hinge (high resistance upon request)
- Angle can be locked in place with the tilt lever

MNTQ with Quick Release Plate
MNT without Quick Release Plate

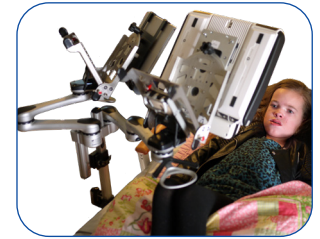
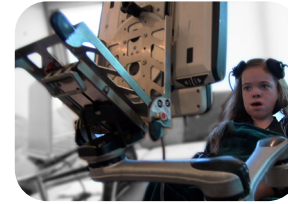

Table Clamp

Attach your mount to a table!

- Quickly adjust tilt, height and positioning
- Conduct evaluations easily
- Clamps to tables and trays (1/2" to 3")
- Attach above or below table
- Move a mount from a table to a wheelchair easily

TC



Sophia uses eye gaze (on a double decker system) to access her communication device

Stand + 90°

Two products in one!

DOWNWARD TILT for mounted devices

- Attach between a device plate or tray and Quick Release Plate
- Ideal for eye gaze access from bed
- Locks at 0°, 55° and 90°
- Use tilt lever to lock 0-180°

TABLE STAND for devices or trays

- Use with any device plate or tray
- Locks at 0° and 55° on tables

DP-STAND90

Connect your mount to your wheelchair

* For more information see [Interactive Product Chooser](#) at [mountnmover.com](#)

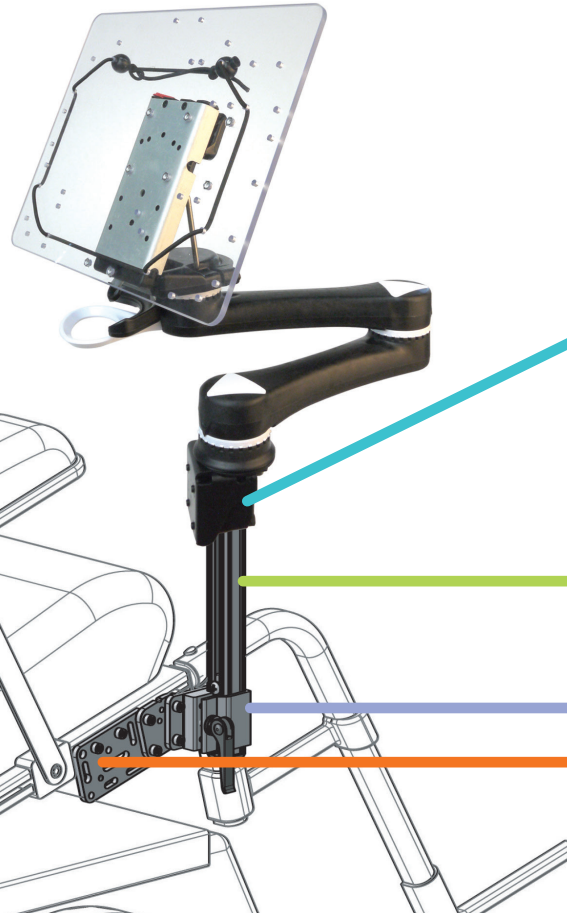

Questions?

Give us a call and we can help select the best mounting option for your wheelchair. From round tubing to slide tracks, level or angled, we have the hardware to connect your Mount'n Mover to your wheelchair.

For Dual Arms, Single Arms, Tilt'nTurner, and Easy Movers, the Link Cube offers three attachment options:

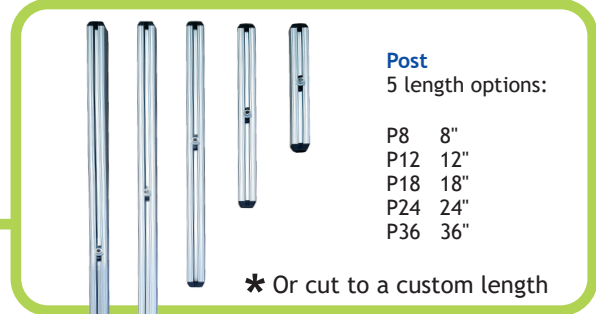
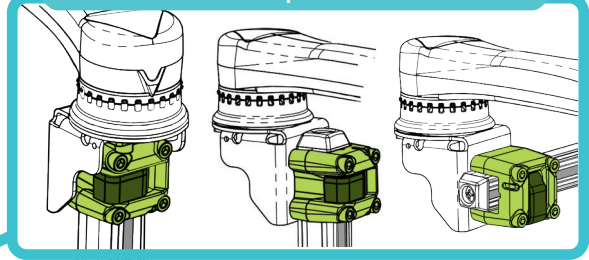

Post
5 length options:

P8 8"
P12 12"
P18 18"
P24 24"
P36 36"

* Or cut to a custom length

Call us at 1-888-724-7002
(toll free) or 1-612-724-7002.

For help choosing hardware go to:

mountnmover.com/support/wheelchair-mounting-overview

Select your wheelchair brand and model from drop down menu to view recommendations and mounting instructions

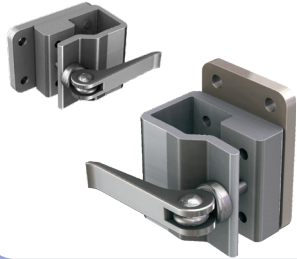

Solid Wheelchair Bracket

- Most rigid way to attach
- Simple and compact
- Has two mounting orientations

WB2

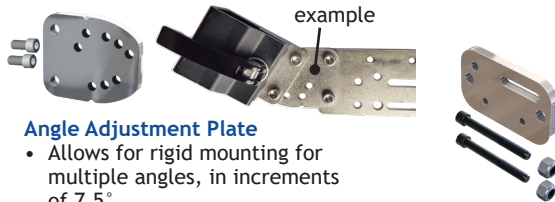

Angle Adjustment Plate

- Allows for rigid mounting for multiple angles, in increments of 7.5°
- Compatible with WB2 and all bracket mounting hardware.

Pair this with WB2 to more solidly adjust your post angle to vertical

WC-AAP

Adapter Plate

- Plate size: 3" x 1.75" x .25"

WC-AP

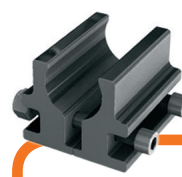

Round Clamp

- Clamps to round tubing when bolting is not an option
- Select from 1" or 7/8" size

WC-R1 1"

WC-R7/8 7/8"



Round Bridge Clamp

- Must be used in a pair with a AP2 or AP4
- Choose 1", 7/8" or mixed pairs
- Eliminates tube-slip if clamped at right-angles

WC-R1B-set 1"

WC-R7/8B-set 7/8"



Coved Spacers

WC-Coved-7/8
WC-Coved-1



Collar Clamps

- Additional round tubing option (see website for sizes)

WC-Collar

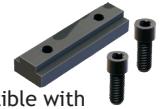

T-Nut

- Compatible with TDX and Quantum style slide tracks

WC-TN

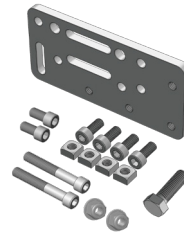

Adapter Plate 2

- Plate size: 4.75" x 2.25" x .25"
- Longer extension than WC-AP4

WC-AP2



Adapter Plate 4

- Plate size: 3.75" x 2.25" x .25"
- More compact than WC-AP2
- Allows for 5/16" or 8mm bolts

WC-AP4



Adapter Plate 5

- Plate size: 5.5" x 2.0" x .25"
- longest/narrowest
- Allows for 5/16" or 8mm bolts

WC-AP5



L-Angled Extension Plate

- Can be used singly to offset mounting at 90°, or used in pairs to extend mounting from 2.25" to 4.5"
- Fully compatible with all wheelchair mounting hardware

WC-LAE

Access anything, anywhere!

Move your Mount'n Mover from your wheelchair to the Floor Stand in seconds!

Shown with Stand+90

Easy access from bed!

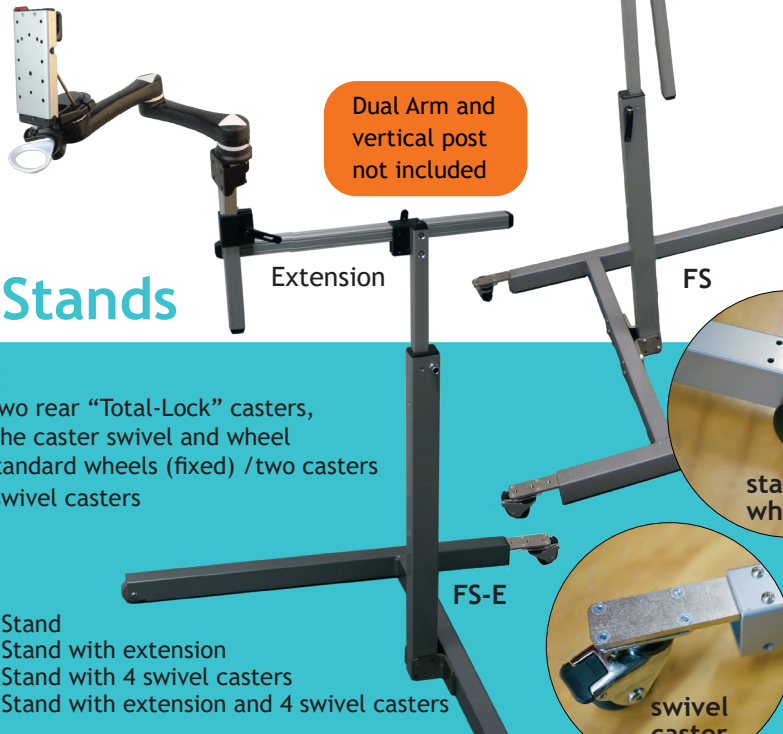

Floor Stands

Wheel options:

- All models: two rear "Total-Lock" casters, able to lock the caster swivel and wheel
- FS has two standard wheels (fixed) /two casters
- FS-4C has 4 swivel casters

- FS Floor Stand
- FS-E Floor Stand with extension
- FS-4C Floor Stand with 4 swivel casters
- FS-4C-E Floor Stand with extension and 4 swivel casters



Eval Kit

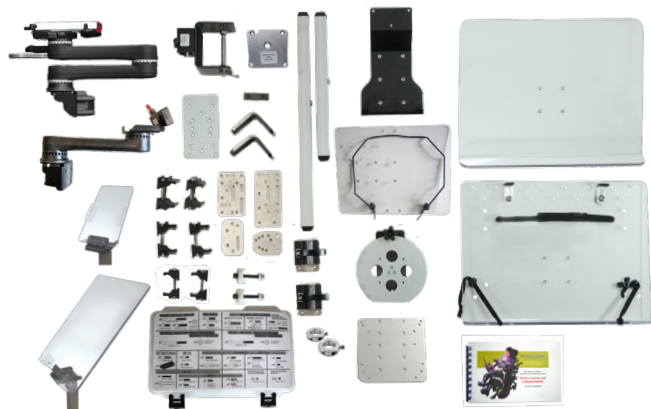
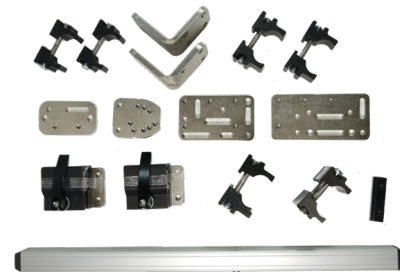

Table Evaluation Kit

SAVE!
Kits and Sets are discounted!



Wheelchair Attachment Set

Additional kits
are available.
Contact us!

Eval Kit:

The Eval Kit includes a Locking Dual Arm, an Easy Mover Single Arm, Simple Mounts, Table Clamp, Device Plates, Wheelchair Hardware, and 3 Trays. Stored in a durable carrying case. See website for complete content details.

We believe in hands-on trials to help a person determine what works best! Our Evaluation Kits provide the tools to mount and position a range of devices on a variety of surfaces. Therapists appreciate how easily the mount can be moved for visual and physical access during evaluations.

Our kits can be customized to fit your population or budget needs. Call us for details.



Meet the Mount'n Mover Loan Program

Test drive one of our mounts with our Meet the Mount'n Mover loan program. Our 2-week trial period provides the opportunity to try before you buy! See our website for details.

Comes with durable carrying case

Table Eval Kit

Kit comes with Table Clamp, iPad/Tablet Tray, Tray with Lip, one 18" Post, and Dual Arm Mount'n Mover EVAL-T

Wheelchair Attachment Set

This 16 piece set includes an 18" Post, the Solid Wheelchair Bracket, multiple plates, and assorted mounting hardware. Will attach to most standard wheelchairs that have slide track or 7/8" or 1" tubing WC-SET

Mount'n Mover™

by BlueSky Designs

2637 27th Ave. S., Suite 209
Minneapolis, MN 55406-1564

Visit mountnmover.com for:

- Step by Step Guide
- How-to videos
- Wheelchair mounting support
- Resources for therapists
- Loan and rental program



Alma uses a Mount'n Mover Single Arm to hold her communication device. Recently we helped to install it on her new wheelchair.

"First of all, I just want to sincerely thank you and the team for taking the time to put together such a specialized and unique mount for my chair! Having my device mounted on my chair has been such a quality-of-life improvement, and it has greatly enhanced my independence, both at work and at home. It has also relieved much of the back pain that I had been experiencing as a result of holding my device on my lap. You guys have my gratitude and my respect for your handiwork!"

Alma S.

mountnmover.com

1-888-724-7002 (toll free) or 1-612-724-7002
info@blueskydesigns.us