

Mount'n Mover

by BlueSky Designs

Order Sheet

www.mountnmover.com
 Phone: 612.724.7002 // 888.724.7002
 Fax: 888.311.4435 // Intl Fax: 612.724.7004

Follow these steps to fully specify a Mount'n Mover system.

Client Name: _____
 Chair Type: _____
 Second Chair: _____
 Device(s) to Attach: _____
 Contact Name: _____
 Email / Phone: _____

Step 1 : Choose a Mount'n Mover

Note: Dual, Single Arm and Tilt'n Turner all come with a Quick Release Plate (QRP)

Dual Arm Mount'n Mover



M2-TQ-H *
 (High Resistance Hinge)
M2-TQ-L *
 (Low Resistance Hinge)

Single Arm Mount'n Mover



M1-TQ-H *
 (High Resistance Hinge)
M1-TQ-L *
 (Low Resistance Hinge)

Tilt'n Turner



M0-TQ-H *
 (High Resistance Hinge)
M0-TQ-L *
 (Low Resistance Hinge)

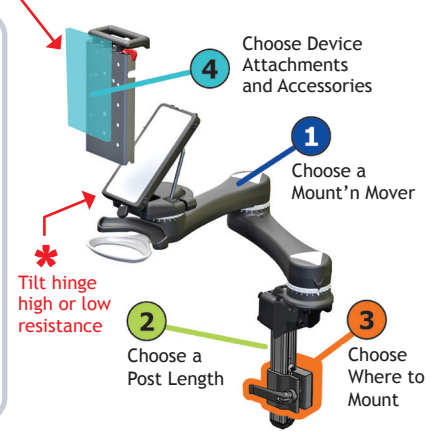

EASY MOVERS

Easy Mover with Quick Connect Receiver (dual and single arm)



EM2-QC-H *
EM2-QC-L *
 (Quick Connect Plate -QCP not included with Easy Movers)
EM1-QC-H *
EM1-QC-L *

Easy Mover with Tilt Plate (locking tilt plate)



Dual
 Single
 (QRP not included with Easy Movers)

EM2-LTP-H*
EM2-LTP-L*
EM1-LTP-H*
EM1-LTP-L*

Easy Mover Tilt'n Turner (non-locking tilt)

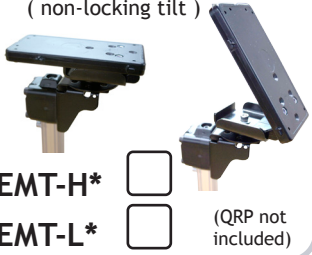

EMT-H*
EMT-L*
 (QRP not included)

Easy Mover with Tilt Plate (non-locking plate)



Dual
 Single
 (QRP not included with Easy Movers)

EM2-TP-H*
EM2-TP-L*
EM1-TP-H*
EM1-TP-L*

Quick Release Plate



Not included with Easy Movers.
QRP

* Tilt Hinge Resistance:

We recommend the High Resistance Hinge for heavier devices (5 lbs. [2.3 kg] or greater).

The High Resistance Hinge deters device angle adjustment when the tilt lever is unlocked. Both **H** and **L** hinges can be securely locked using the tilt lever lock.

SIMPLE MOUNTS

Simple Mount Large



Post Included. Choose Post length below
 Two Lip Supports Included

SM-LG-H *
SM-LG-L *

Simple Mount Small



Post Included. Choose Post length below
 One Lip Support Included

SM-S-H *
SM-S-L *

Simple Mount with Quick Connect Receiver



SM-QC-H *
SM-QC-L *

Additional Lip Supports

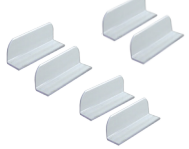

Set of six

TRA-LS-1/2
 (1/2" tall x 2" long)
TRA-LS-1
 (1" tall x 2" long)

Step 2 : Choose a Post Length

Minimum post length is determined by the distance from the mounting point to the bottom of a person's tray or device when it is in his/her preferred operating position.

Measure **Distance A** in the diagram and select the next longest post.



- 8" Post **P8**
- 12" Post **P12**
- 18" Post **P18**
- 24" Post **P24**

Custom Post Length inches*

* Custom post lengths available.

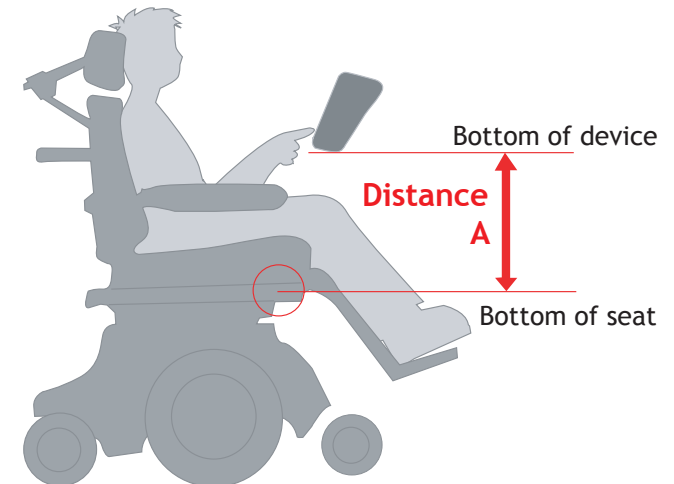

Step 3 : Choose Where to Mount

Mount to any combination of Wheelchair, Table or Floor Stand

3 : Table Solutions

Mount'n Tilter

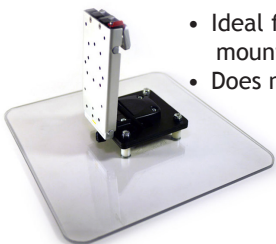

- Ideal for surface mounting
- Does not include QRP

MNT

Table Clamp



- Attach your mount to a table!
- Designed for use with Post & Mount

TC

Stand +90°



- Table stand for devices
- Downward tilt for mounted devices

DP-STAND90

3 : Floor Stands

Basic Floor Stand



Use your Mount'n Mover on a Floor Stand, move from wheelchair or table to Floor Stand in seconds. Easy access from bed!

Floor Stand Options

FS (Basic Floor Stand)

Options:

- **4C**
(4 "total lock" casters)

- **E**
(Horizontal Extension)

Adds up to a 16" horizontal extension

Basic FS has 2 in-line wheels and 2 "Total-Lock" casters



in-line wheel



total-lock caster



Angle adjustment $\pm 10^\circ$ for weight compensation

Adjustable extension up to 16"

Horizontal Extension Option:

3 : Attach to "other brand" Systems

Wheelchair DAESSY adapter



Compatible with DAESSY wheelchair hardware.

WB-DAESSY

Tilt Plate Adapter

Compatible with DAESSY and Rehadapt. Other sizes available.



DP-TPA
1" or 7/8"

1"
7/8"

Tilt Plate Adapter with Quick Connect Plate

Compatible with Rehadapt/Connect-it Table or Floor Stand

Attaches to BlueSky Design's Quick Connect Receiver

DP-TPA-QCP



Examples:



Rehadapt plate not included

Shown with Quick Release Plate attached to the Tilt Plate



Quick Connect Receiver

3 : Wheelchair Mounting

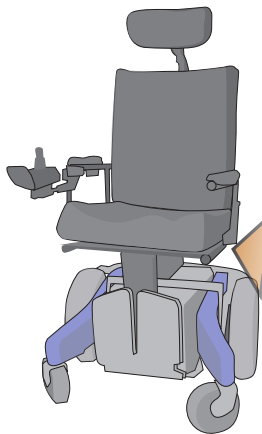

3a

Mounting Hardware & Offset*

+



3b

Wheelchair Bracket

Overview

Wheelchair Mounting is divided into two stages:

3a Select Mounting Hardware

- Direct Wheelchair Attachment
- Offset Components
(Offset components are optional)

3b Select Wheelchair Bracket(s)

The Bracket is attached to the Mounting Hardware selected from 3a.

The Mount'n Mover Post is then inserted into the Wheelchair Bracket square clamp.

Wheelchair Mounting - 3a Select Mounting Hardware

See Website for Wheelchair Mounting Guide

Multi-Purpose Plates

All Adapter Plate(s):

- Can be used with bridge clamps.
- Accommodate a range of spacing for 1/4" or 6mm bolts.

Adapter Plates 2, 4, 5 can be used for:

- Permobil UniTrack
- Permobil Corpus
- Quantum/Jazzy Tie-Downs

Adapter Plate

(3.0" x 1-3/4")



Most compact plate For Hole Spacing 1"-2"

WC-AP

Adapter Plate 2

(4-3/4" x 2-1/4")



- Longer plate for offset

WC-AP2

Adapter Plate 4

(3-3/4" x 2-1/4")

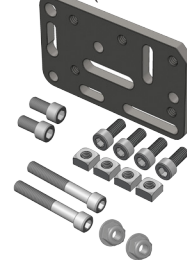

- More attachment options
- Also for 5/16" or 8mm bolts

WC-AP4

Adapter Plate 5

(5" x 2")

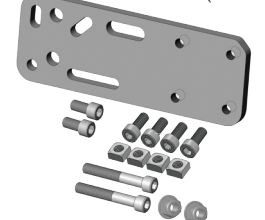

- Longest Adapter Plate
- Compatible with Permobil and T-nut
- 4 threaded holes

WC-AP5

Wheelchair Mounting - 3a Select Mounting Hardware (cont.)

T-Nut



Compatible with Invacare and Quantum slide track.

WC-TN

Bridge Clamp

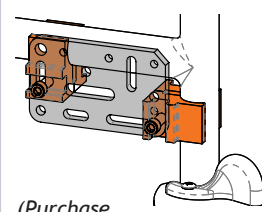

(Purchase Adapter Plate separately)

Bridge clamps must be used in pairs, spanned with an adapter plate.

Set of 2



1" Bridge Set **WC-R1B-SET**

7/8" Bridge Set **WC-R7/8B-SET**

Mixed Set (1 ea.) **WC-R-Mixed-SET**



1" Bridge (1)

7/8" Bridge (1)

Collar Clamp



Additional round tubing options (see website for sizes)

WC-Collar

Round Clamp

For mounting *vertically* to round tubing

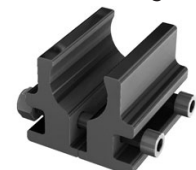

1" Clamp **WC-R1**

7/8" Clamp **WC-R7/8**

Coved Spacer



- Through hole in frame
- Provides stability for plate attachment

wc-coved-1-set

wc-coved-7/8-set

Offset Options

Why Offset?

- Get around obstacles like trays, brakes, footrests and armrests.
- Position the Wheelchair Brackets and post for best position.
- Compensate for mounting angle so the post is vertical.

Adapter Plate(s) can also be used to offset mounting forward or upward.

Offset Example

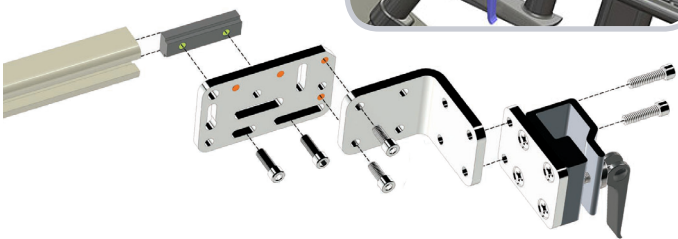

L-Angle Extension



Can be used in pairs to extend mounting up to 7"

WC-LAE

Quantity

Adapter Plate(s)



AP2 is a longer offset. AP4 has more options.

WC-AP2

WC-AP4

Angle Adjust Plate



Compatible with any mounting component. Adjust post to vertical (every 7.5°).

WC-AAP

Adapter Plate



4 threaded holes for Link Cube

Our longest plate. Link Cube attachment. Even more options!

WC-AP5

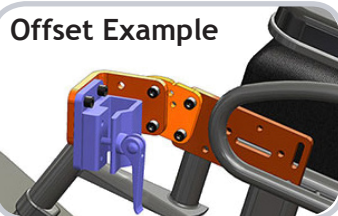

Post Extension Kit



Available in other post lengths

PEK-12

Wheelchair Mounting - 3b Select Wheelchair Bracket(s)

Solid Wheelchair Bracket

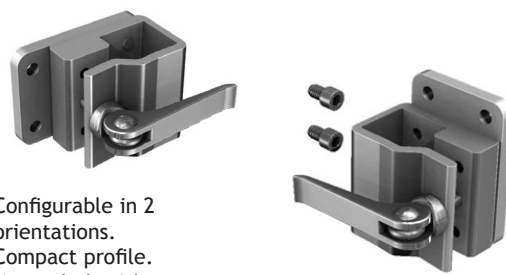

Configurable in 2 orientations. Compact profile. Minimal play/slop. More secure.

WB2

Tip: Adjust the angle of the post with the WC-AAP plate

WC-AAP (Angle Adjust Plate)

Use the WB2 with the WC-AAP for mounting at an angle (7.5 degree increments)

Step 4 : Choose Device Attachments & Accessories

Access anything, anywhere! Select access for one or multiple devices and trays

4 : BlueSky Designs Accessories

Quick Release Plate



One included with each Mount'n Mover.

QRP

Quick Connect Receiver and Plate

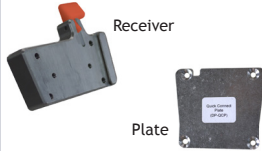

Compatible with many speech devices and mounts

DP-QCR
DP-QCP

Universal Rotator



Add a degree of freedom between tilt and device. Great for eyegaze and tablets.

DP-UR

Camera Plate



Turns a Quick Release Plate into a camera stand! Compatible with other tripod heads

DP-CAM3

Stand +90°



Extend your downward tilt range to 180°. Also use as a table stand for devices

DP-STAND90

4 : Tray Options - Reading, Laptops, iPads, etc

Note: If attaching more than one device, you will need additional QRP's or DP-QCP's

TR-LG Tablet Tray

Overall size: 14" x 9-3/4"



Multi-purpose tray for larger tablets over 11 x 8 inches
-iPad Pro 12.9
-Surface Pro -etc

TR-LG Tablet
Add QRP

TR-Small Laptop Tray

Overall size: 14" x 9-3/4"



Tray for Lingraphica All Talk Device and small laptops (13 x 9" or smaller)

TR-Small Laptop Tray
Add QRP

iPad-Tablet Tray

UR not included

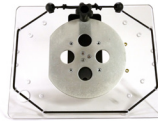

Overall size: 12" x 9-1/2"

Great for iPad and Tablet. Easily switch from landscape to portrait with Universal Rotator (shown).

TR-iTab
TR-iTab-UR
(With Universal Rotator)
Add QRP
Add DP-QCP

Laptop Tray

Overall size: 12" x 16"

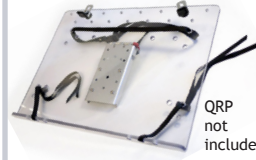

Tray, holes and straps fit most laptops securely. Easily remove your laptop.

TR-LT
Add QRP
Add DP-QCP



Add a Swing Away Tray on a 12 x 16" Tray or a Laptop Tray to hold a mouse, phone or other small device. Right, left or both sides. See website for more information.

12"x 16" Tray with Lip

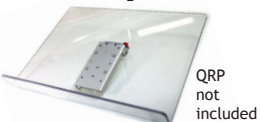

QRP not included

Multi-purpose tray with lip. Great for books, tablets, etc. Angle it flat and turn it around for writing or eating.

TR-12x16
Add QRP
Add DP-QCP

12"x 12" Tray

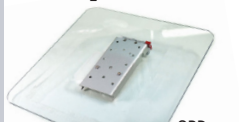

QRP not included

Multi-purpose tray. Adapt it for your needs.

TR-12x12
Add QRP
Add DP-QCP

Phone Plate

Landscape or portrait



Attachment plate for mobile phone. Includes an Otterbox Defender swivel case. Shown with Quick Release Plate (not included).

Phone make and model _____
DP-PHONE-OB

Tablet Tray (with hinge tray)



TR-iTab-Keyboard
9.5" x 12" (x2)
Add QRP
Add DP-QCP

④ : Communication Device Attachments

Attach any Device with Ease

Device plates attach communication devices to the Mount'n Mover's Quick Release Plate (QRP) or Quick Connect Receiver (QCR).
One QRP comes with each Locking Dual, Single Arm and Mount'n Tilter

Device make and model: _____

Device Plate: _____

Find the attachment plate for your device			
MAKE	MODEL	PLATE	
For devices not shown - contact us		For use with Quick Release Plate (QRP)	For use with Quick Connect Receiver (QCR)
Tobii Dynavox	SC Tablet Pro (12.9 iPad)	DP-QCP plus DP-QCR	DP-QCP
	SC Tablet (iPad)	DP-QCP plus DP-QCR	DP-QCP
	EyeMobile Plus (EM12 with EyeMobile Plus)	DP-QCR	QCR COMPATIBLE
	EyeMobile	DP-T3	QRAP **
	I110	DP-T4	DP-T4 plus DP-QCP
	Indi	DP-QCR	QCR COMPATIBLE
	I12, I15	DP-T2	DP-T2 plus DP-QCP
	I13, I16	DP-T5	QCR COMPATIBLE
	C8, C12, CEye, S32	DP-T1	DP-T1 plus DP-QCP
	Maestro, T10, T15, V, Vmax, M3, DV4, MT4	DP-DV1	DP-DV1 plus DP-QCP
Prentke Romich Co. and Saltillo	Accent 700, 800, 1000	DP-PRC5	QRM *
	Accent 1400, ECO2, ECOpoint, ECO-14, Vanguard, Pathfinder 2	DP-PRC1	DP-PRC1 plus DP-QCP or QRM *
	Accent 1200, Vantage Lite, Springboard Lite	DP-QCR *	QRM *
	NOVA chat 8, 10, 12, Chat Fusion 8,10, TouchChat Express	DP-QCR *	QRM *
Control Bionics	Neuronode Trilogy	DP-MULTI1	DP-MULTI1 plus DP-QCP
Forbes	Winslate 12, 11, ProSlate 8, 10, 13	DP-QCP plus DP-QCR	DP-QCP
Talk to Me Technologies	Eyespeak 12, Zuvo 10, 12, Wego 10+13	DP-QCR	QCR COMPATIBLE
	Eyespeak 18, Zuvo 18	DP-QCR-E	
EYEGAZE Inc	Eyegaze Edge	DP-EE	DP-EE plus DP-QCP
Smartbox	Grid Pad 12	DP-QCR-E	QCR COMPATIBLE
Others	(Jabbla)-Mobi/Tellus, (Abilia)-Rolltalk, AMDI, VESA (50,75,100mm)	DP-MULTI1	DP-MULTI1 plus DP-QCP
iPad/Tablets	Fits standard iPads / Tablets (11 x 8 inch maximum)	TR-iTAB	TR-iTAB plus DP-QCP
Large Tablets	iPad Pro 12.9, Surface, Surface Pro (13.5 x 9.5 maximum)	TR-LG Tablet Tray	TR-LG Tablet Tray plus DP-QCP
Small Laptops	Lingraphica All Talk, Small Laptops (13 x 9 inch maximum)	TR-Small Laptop Tray	TR-Small Tablet Tray plus DP-QCP
Rehadapt	DP-QCR and DP-QCP are Rehadapt compatible **Requires Tobii Quick Release Adapter Plate		*Requires PRC'S QRM plate

NOTES: _____
